

# **2021-2022 Official Rules & Regulations**



**DYBUSA.org**

# 2022 League Insurance

Endorsed By Dixie Youth Baseball, Inc

## 2022 Insurance Rates

### Accident (\$250,000) – No Deductible

| DIVISION                                | RATE PER TEAM |
|---|---------------|
| AAA Majors (12 & under)                 | \$15.30       |
| O-Zone (12 & under)                     | \$15.30       |
| AA Minor (10 & Under)                   | \$13.25       |
| Coach Pitch (8 & Under)                 | \$10.25       |
| A T-ball / Instructional (4 & Under)    | \$10.25       |
| Buddy Ball (16&Under) (Player Assisted) | \$14.20       |

**General Liability (\$2,000,000) \$41.15**

### Directors & Officers Liability

\$315 flat charge per league - \$1,000,000 Limit of Coverage

\$473 flat charge per league - \$2,000,000 Limit of Coverage

### Crime Insurance (\$25,000)

\$200 flat charge per league

### Equipment Insurance

\$2.00 per \$100 of coverage (\$200 minimum premium)

**Fall Ball coverage is automatically included in the Accident & General Liability for no additional charge.**  
*(Applies to same age groups insured in the spring)*

**Apply For Coverage Online And Print Your Proof Of Coverage Documents, Certificates Of Insurance For Property Owners, And Claim Forms Within Seconds!**



**John Sadler**

# SADLER

**SPORTS & RECREATION INSURANCE**

Email: [dixie@sadlersports.com](mailto:dixie@sadlersports.com)

[www.sadlersports.com/dixiev](http://www.sadlersports.com/dixiev)

Phone: 1-800-622-7370

Fax: 803-256-4017

©1999-2022 Sadler & Company All Rights Reserved



## **OFFICE OF THE COMMISSIONER**

**P.O. BOX 1286**

**WETUMPKA, ALABAMA 36092**

**TELEPHONE (334) 265-0294**

**Email address: [william@dybusa.org](mailto:william@dybusa.org)**

### **ADMINISTRATIVE OFFICES**

**DYB SUPPLY CENTER**

**PO BOX 877**

**MARSHALL, TEXAS**

**(903)927-2255**

**[dyb@dybusa.org](mailto:dyb@dybusa.org)**

### **SUPPLY CENTER WEBSITE**

**<http://dybstore.org>**

### **OFFICERS**

BRUXVOORT, KENT (President) 2700 West Amour Drive, Rogers, AR 72758. Cell: (501) 279-8663. Email: [kent\\_bruvoort@cargill.com](mailto:kent_bruvoort@cargill.com)

JACKSON, DAVID (Vice President) 609 Armory Rd., Parkton, NC 28371. Cell (910) 703-5649. Email: [wolfpackjack@aol.com](mailto:wolfpackjack@aol.com)

HUDGINS, ROBERT (Secretary), 407 West Race, Searcy, AR 72143. Business (501) 268-1111, Cell (501) 278-7377. Email: [judginslaw@att.net](mailto:judginslaw@att.net)

SKELTON, WES (Treasurer) P.O. Box 877, Marshall, TX 75671  
Cell (903) 926-0400 Email: [wes@dybusa.org](mailto:wes@dybusa.org)

WADE, WILLIAM (Commissioner) P.O. Box 1286, Wetumpka, AL 36092. Cell: (334) 265-0294. Email: [william@dybusa.org](mailto:william@dybusa.org)

BENNETT, JAY (Deputy Commissioner) 102 Nettles Park Road, Clemson, SC 29631. Business (864) 624-1122 Email: [jbennett@cityofclemson.org](mailto:jbennett@cityofclemson.org)

# TABLE OF CONTENTS

|                                    |             |  |        |
|------------------------------------|-------------|--|--------|
| AA Tournament Rules.....           | 93-96       | Local League Option Definition.....        | 29     |
| Admission to Games.....            | 73          | Manager, Definition.....                   | 29     |
| Age Charts.....                    | 4-5         | Names and Addresses, Directors.....        | 6-14   |
| Age, Proof of.....                 | 71-72,81    | Official Playing Rules.....                | 19-65  |
| Age, Requirements.....             | 4,5,71      | Non-Discrimination Policy.....             | 1      |
| Baseball, Official.....            | 20-21       | Participation in Other Programs.....       | 73     |
| Bases.....                         | 20          | Participation, Offensive Requirements..... | 31-34  |
| Base Runner's Path.....            | 19          | Pitcher Limitations -Regular Season.....   | 59-60  |
| Bats, Approved.....                | 21          | Pitching Rules, Tournament.....            | 82-84  |
| Batter's Helmet.....               | 22          | Pitcher's Plate.....                       | 20     |
| Batter's Box.....                  | 19          | Placement of Players.....                  | 70-71  |
| Birth Certificates-Affidavits..... | 72          | Playing Field Diagrams.....                | 17-18  |
| Boundaries.....                    | 67-68       | Play Situation, Definition.....            | 30     |
| Brackets, Tournament.....          | 97-108      | Protests.....                              | 59     |
| Catch, Definition.....             | 25          | Protests, Tournament.....                  | 90-91  |
| Catcher's Box.....                 | 19          | Registration of Players/Coaches.....       | 71     |
| Catcher's Helmet.....              | 23          | Regulation Game.....                       | 38-39  |
| Championship Game Definition.....  | 25          | Replacement of Players, Tournament.....    | 82     |
| DYB Child Protection Plan.....     | 74          | Rosters, Regular Season.....               | 70-71  |
| Clothing & Uniforms.....           | 21          | Rosters, Tournament Affidavit.....         | 80-81  |
| Coach, Definition.....             | 25          | PoolPlay Tournament Formats.....           | 98-100 |
| Coaches on Baselines.....          | 35          | Rule Changes 2020.....                     | 3      |
| Complete Time at Bat.....          | 25          | Runner.....                                | 48-55  |
| Conduct and Sportsmanship.....     | 74          | Schedules, Regular Season.....             | 72     |
| Dates to Remember.....             | 16          | Scorer, Official.....                      | 62     |
| Democratic Action.....             | 2           | Selection of Players.....                  | 70     |
| Directors, District.....           | 10-14       | Series, Definition.....                    | 38     |
| Directors, National.....           | 6-9         | Sponsors.....                              | 73     |
| Eligibility, Tournament Teams..... | 77-79       | Substitutions.....                         | 33-35  |
| Foul Tip on Third Strike.....      | 47          | Time-Out, Defense.....                     | 43     |
| Free Substitution.....             | 34,87       | Time-Out, Offense.....                     | 43-44  |
| Home Plate.....                    | 20          | Time-Out, Injury/Sickness.....             | 44     |
| Illegal Substitution.....          | 32,41       | Tobacco Use Prohibited.....                | 73     |
| Index, Official Playing Rules..... | 63-65       | Tournament Rules.....                      | 75-96  |
| Injuries.....                      | 23,33,86-87 | Uniforms, Tournament.....                  | 88     |
| Insurance, Tournaments.....        | 77          | Unsportsmanlike Conduct – Reg Season.....  | 73-74  |
| Leaving Base Too Soon.....         | 54          | Unsportsmanlike Conduct-Tournament....     | 89     |

# OFFICIAL STATEMENT OF POLICY

***Dixie Youth Baseball Inc. (“DYB”) is a non-discriminatory community-based organization which aims to promote fair play for all participants through the uniform adherence to DYB Official Rules, Policies & Regulations. DYB is fully committed to equal opportunity and abides by all applicable federal, state and local laws pertaining to nondiscrimination and fair practices. Dixie Youth Baseball does not and shall not discriminate on the basis of race, color, region, ethnicity or disability.***

It is the policy of DYB to promote the development of strong character, a right attitude, a sense of responsibility, and citizenship in youngsters, using the game of baseball as a vehicle. It is the purpose of DYB to achieve this goal through fair play, good sportsmanship, and congenial fellowship, with adult leaders providing the example while attempting to limit injury caused by overexertion. It is strictly against the policy of DYB for any person, either as a participant or a spectator, to engage in arguments, to use abusive language, to harass umpires, or to exhibit any behavior not in concert with the general intention of this policy statement. Team coaches are required to abide by this policy statement, and all parents and other adults are strongly encouraged to do so.

## **INTENT OF DYB ORGANIZERS**

The fundamental intent of the organizers of Little Boys Baseball, Inc., was to develop a program which would emphasize local autonomy. It was their philosophy and belief that the parents and volunteer workers in each local league know what is best for them and their children. Since the mores (customs) of our people vary from community to community, even within the same districts, it was necessary to leave such things as night baseball, team selections, and league operation up to the local leagues. Certain fundamental rules were imposed upon the leagues that were deemed necessary for good organization and to keep one league from gaining an unfair advantage over another such as boundary and population limitations, the number of teams in a league, and the age brackets.

The next important philosophical belief was that the leagues affiliated with the program should have a voice in the running of the program. Thus, the provision for electing national board members from among the leagues to serve with the organizers was made. It should be borne in mind that at the outset there were no provisions for state organizations, nor state or district directors. The original concept of governmental structure was the Board of Directors and the leagues. The necessity for state directors was realized shortly after organizing and soon after the need for district directors became apparent. There is nothing specific in our constitution concerning state organizations, state directors, or district directors. Any governmental structure between the local leagues and the national board exists for one reason— to serve the local leagues as administrative adjuncts of the board. The idea of local leagues being dominated by a district or state organization is in direct conflict with the original philosophy. The imposition of any rule on a local league should be done with utmost reluctance and absolute necessity.

***“Train up a child in the way he should go and, when he is old, he will not depart from it.” - Proverbs 22:6***

## DEMOCRATIC ACTION

The Constitution provides for the election of each member of the National Board of Directors to four-year terms of office.

The nominations for the National Board of Directors and State Directors are mailed to the President on or before May 15 each year and the President or a National Board Member designated by him shall conduct national board and state director elections. Nominations may be made by any league holding a current franchise. The list of nominees is mailed by June 1 to each league, and an online ballot will be used to elect the board members and state director. June 10 is the deadline for leagues to submit their ballots online.

Each state shall elect a member of the board each year for a four-year term.

Newly elected members of the National Board and State Directors terms of office shall commence on October 1 of the year following their election and terminate on September 30 of the year in which their successors are duly elected and qualified. Officers will be elected by the Board of Directors and shall serve three-year terms.

Except for school leagues or the *Boys & Majors Baseball* program, no National Officer, National Director, or State Director shall be permitted to participate in an official capacity in any other organized youth baseball program. Complete qualifications for any person to be eligible for nomination, election, or appointment to any official position within the DYB program above the local level are included in the By-Laws which govern its operation.

Only a duly authorized representative of a franchised league can vote in any matter before district or state meetings. No one person can represent more than one league. NOTE: A duly authorized representative of a league is the league president, or a person designated by him in writing who is active currently in the voting league.

Leagues are assigned to districts within a state and are under the direction of a district director. District and state directors are under the direction of the national commissioner. There shall be no State Constitution or By-Laws in conflict with the intent, aims, purposes, and the policies and rules of the National DYB organization.

All tournament sites are determined by each state organization with all leagues having equal opportunity in hosting the event provided the league can comply with the requirements established by the state organization. The state requirements are to be determined in advance by each state and announced accordingly.

When the Board of Directors is not in session and a proposed change is of the utmost importance and urgency, the Rules Committee may authorize an online ballot to be sent to each committee member and/or a conference call will be conducted by a quorum of the committee for discussion and approval to submit recommendation to the Executive Committee for approval. Any adopted rule changes will become effective for the next printing of the rule book following adoption by the National Board of Directors.

---

---

The National Board of Directors has granted the states the right to charge a fee for operating state programs. The states have the right to charge these fees and to penalize any league that does not pay their fees provided that the State Constitution, authorizing such charges, is on file with the Commissioner.

## IMPORTANT!! USE YOUR RULE BOOK

The following rule changes were adopted by the DYB National Board of Directors at its annual meeting in August 2020 and 2021. The updated 2021-22 DYB Rule Book is online on the DYB website at [dybusa.org](http://dybusa.org). This online rule book will be used for the 2022 seasons. See significant changes made in 2021 and 2022 below:

---

---

### 2022 SIGNIFICANT RULE CHANGES

1.10-(c) Tee Ball Bats – Tee Ball bats will be stamped with the USA Baseball Mark and the language “Only for use with approved tee balls”. Bats stamped for Tee Ball (T-Ball) play can only be used with low compression balls due to the manufacturing standards for these bats. Any bat stamped for Tee Ball (T-ball) play cannot be used in games played using a regular baseball that is pitched to the batter in any division of DYB.

**6.06(d) “O”Zone Play** - With a runner on 3rd base attempting to steal home with the pitch, THE BATTER MUST BUNT OR TAKE THE PITCH. If the batter swings, the ball will be dead with runners returning to their original bases, the batter will be called out, and the team manager will be EJECTED. NO WARNING will be given in this situation. Exception: No penalty will be assessed when the bases loaded with two outs and full count on the batter.

---

---

### 2021 SIGNIFICANT RULE CHANGES

**Rule 7.08(l) Page 60 – Change paragraph 7.08(l) to read**

(l) A runner wearing a full-face mask, while attempting to reach the next base, attempts a head-first slide. Note: This shall only apply to a runner wearing a full-face mask attempting to reach the next base and does not apply to a dive or attempt to return to a base;

**Regulation I (E) (1) – The League – Page 74 -Change paragraph (E)(1) to read:**

(E)(1) Each franchised league shall be composed of a minimum of three (3) teams and not more than nine (9) teams in the Majors, “O”Zone, AAA and AA Divisions and not more than eleven (11) teams in the A (6U & 4U) divisions.

**Regulation 2(L) - League Boundaries – Page 77 - Add new paragraphs (M)(1) and (M)(2) to read:**

(M) (1) With the written approval of the State and District Director a league may extend their boundary to include players that do not currently reside within the boundary of a league franchised by DYB. This area to be included must be contiguous to the current boundary of that league.

(M) (2) With the written approval of the State and District Director a group of leagues may extend their boundaries to include areas contiguous to the group of leagues that do not currently have a franchised DYB league. Such an area will become a common boundary for that group of leagues. Players from the common boundary may register with any of the contiguous leagues. Once such a player registers and is accepted by a league, that player shall remain the property of that league unless otherwise provided for in these rules.

**Tournament Rule XII (H)-Ineligible Player - Page 101 Change paragraph H(2) to read:**

(2) All protests based on the ineligibility of a player, other than age, shall be filed with the appropriate DYB official prior to the conclusion of the first tournament game played by that player. PENALTY: The penalty shall be the immediate removal of the player from his/her DYB tournament team roster and disqualification from tournament play.

# 2022 DYB Age Chart

Match player's birth month (top row) with year of birth to determine League Age.

| JAN  | FEB  | MAR  | APR  | MAY  | JUN  | JUL  | AUG  | SEP  | OCT  | NOV  | DEC  | LEAGUE AGE |
|------|------|------|------|------|------|------|------|------|------|------|------|------------|
| 2019 | 2019 | 2019 | 2019 | 2018 | 2018 | 2018 | 2018 | 2018 | 2018 | 2018 | 2018 | 3          |
| 2018 | 2018 | 2018 | 2018 | 2017 | 2017 | 2017 | 2017 | 2017 | 2017 | 2017 | 2017 | 4          |
| 2017 | 2017 | 2017 | 2017 | 2016 | 2016 | 2016 | 2016 | 2016 | 2016 | 2016 | 2016 | 5          |
| 2016 | 2016 | 2016 | 2016 | 2015 | 2015 | 2015 | 2015 | 2015 | 2015 | 2015 | 2015 | 6          |
| 2015 | 2015 | 2015 | 2015 | 2014 | 2014 | 2014 | 2014 | 2014 | 2014 | 2014 | 2014 | 7          |
| 2014 | 2014 | 2014 | 2014 | 2013 | 2013 | 2013 | 2013 | 2013 | 2013 | 2013 | 2013 | 8          |
| 2013 | 2013 | 2013 | 2013 | 2012 | 2012 | 2012 | 2012 | 2012 | 2012 | 2012 | 2012 | 9          |
| 2012 | 2012 | 2012 | 2012 | 2011 | 2011 | 2011 | 2011 | 2011 | 2011 | 2011 | 2011 | 10         |
| 2011 | 2011 | 2011 | 2011 | 2010 | 2010 | 2010 | 2010 | 2010 | 2010 | 2010 | 2010 | 11         |
| 2010 | 2010 | 2010 | 2010 | 2009 | 2009 | 2009 | 2009 | 2009 | 2009 | 2009 | 2009 | 12         |



**Dixie Youth Baseball®**, Inc.  
**OFFICE OF THE COMMISSIONER**  
**WILLIAM WADE, COMMISSIONER**  
**P.O. BOX 1286**  
**WETUMPKA, ALABAMA 36092**  
**TELEPHONE (334) 265-0294**  
**Email address: [william@dybusa.org](mailto:william@dybusa.org)**  
**Website: [DYBUSA.org](http://DYBUSA.org)**

**OFFICERS**

BRUXVOORT, KENT (President) 2700 West Amour Drive, Rogers, AR 72758. Cell: (501) 279-8663. Email: [kent\\_bruvoort@cargill.com](mailto:kent_bruvoort@cargill.com)  
JACKSON, DAVID (Vice President) 609 Armory Rd., Parkton, NC 28371. Cell (910) 703-5649. Email: [wolfpackjack@aol.com](mailto:wolfpackjack@aol.com)  
HUDGINS, ROBERT (Secretary), 407 West Race, Searcy, AR 72143. Business (501) 268-1111, Cell (501) 278-7377. Email: [judginslaw@att.net](mailto:judginslaw@att.net) SKELTON, WES (Treasurer) P.O. Box 877, Marshall, TX 75671 Cell (903) 926-0400 Email: [wes@dybusa.org](mailto:wes@dybusa.org)  
WADE, WILLIAM (Commissioner) P.O. Box 1286, Wetumpka, AL 36092. (334) 265-0294. Email: [william@dybusa.org](mailto:william@dybusa.org)  
BENNETT, JAY (Deputy Commissioner) 102 Nettles Park Road, Clemson, SC 29631 Business (864) 624-1122 Email: [jbennett@cityofclemson.org](mailto:jbennett@cityofclemson.org)

**STATE AND NATIONAL DIRECTORS**

**ALABAMA**

PHATURUS, RICKY (State Director) 3709 Lewis Lane, Montgomery, AL 36109 Cell: (334) 224-8027. Email: [aldyb.rp@gmail.com](mailto:aldyb.rp@gmail.com)  
BELL, CHARLIE (National Director) 1430 West Saunders Rd., Dothan, AL 36301. Cell (334) 685-0851, Email: [charliebell44@gmail.com](mailto:charliebell44@gmail.com)  
FILLINGHAM, JACK (National Director) PO Box 780428, Tallassee, AL 36078. Cell (334) 303-8123. Email: [JPFdyb@aol.com](mailto:JPFdyb@aol.com)  
PHILLIPS, DALE (National Director) 5518 Chestertown Trace Northport, AL 35475 Cell: (205) 454-8259 Email: [dalephillips20@aol.com](mailto:dalephillips20@aol.com)

**ARKANSAS**

BUCHANAN, JESSE (State Director), 2021 Hickory St., Texarkana, AR 71854. Home (870) 772-5728. Email: [jessedyb@cableone.net](mailto:jessedyb@cableone.net)  
HUDGINS, ROBERT (National Director), 407 West Race, Searcy, AR 72143. Business (501) 268-1111, Cell (501) 278-7377. Email: [judginslaw@att.net](mailto:judginslaw@att.net)  
JACKSON, CHARLES (National Director), 10 Arnold Drive, Texarkana, AR 71854. Home Cell: (903) 748-8332 Email: [cljlap13@gmail.com](mailto:cljlap13@gmail.com)  
STORY, LYNN (National Director), 115 South Court Square, Magnolia, AR 71753. Business (870) 234-7020. Email: [lynn@storyonthesquare.com](mailto:lynn@storyonthesquare.com)

## FLORIDA

SMITH, TONY (State Director), 920 Belmont Ave., Mulberry, FL 33860. Cell (863) 660-7528. Email: [floridadyb@gmail.com](mailto:floridadyb@gmail.com)

COX, BRIAN (National Director), 133 South 2nd Street, Wewahitchka, FL 32465. Home (850) 639-5066, Cell (850) 832-6009, Work (850) 639-3506. Email: [fldyb4@fairpoint.net](mailto:fldyb4@fairpoint.net)

MORRIS, DON (National Director), 322 N. Calhoun St., Quincy, FL 32351. Home (850) 627-3660, Cell (850) 210-3924. Email: [dm4fsu@msn.com](mailto:dm4fsu@msn.com)

RUDD, SAM (National Director) 3410 Willis Road, Mulberry FL 33860 Cell: (863)712-1562 Email: [professorrudd@tampabay.rr.com](mailto:professorrudd@tampabay.rr.com)

## GEORGIA

GLOYD, DAVID (State Director) 4743 Amsterdam Lane, Flowery Branch, GA 30542. Cell (770) 630-8214. Email: [davidgloyd@aol.com](mailto:davidgloyd@aol.com)

COLBERT, TRUBY (National Director) 179 Mica Rd., Yatesville, GA 31097 Business (770) 584-4832. Email: [colbertga3@yahoo.com](mailto:colbertga3@yahoo.com)

USRY, BRIAN (National Director) 1283 Brewton Drive, Stapleton, GA 30823 Cell (706) 831-4971 Email: [rbusry@yahoo.com](mailto:rbusry@yahoo.com)

KELLEY, JR., DOUG (National Director) PO BOX 1059 Roberta, GA 31078. Cell: (478) 960-8952. Email: [d.kelley@crawfordcountyga.org](mailto:d.kelley@crawfordcountyga.org)

## LOUISIANA

THURSTON, HANK (State Director) 140 Skainswood Pvt. Dr., Downsville, LA 71234. Cell: (318) 791-9381 Home: (318) 397-0956 Email: [hsthurst@gapac.com](mailto:hsthurst@gapac.com)

BERTHELOT, JOHNNY (National Director) 1939 South Tiffani Avenue, Gonzales, LA 70737. Home (225) 644-1316, Cell (225) 266-1883. Email: [jpberthelot@eatel.net](mailto:jpberthelot@eatel.net)

CANTRELL, RANDY (National Director) 2131 McCutcheon Ave., Shreveport, LA 71108. Home (318) 687-9066, Cell (318) 655-8563. Email: [randyc2131@aol.com](mailto:randyc2131@aol.com)

FONTENOT, DESS (National Director) 1545 Rene Ann Dr., Ville Platte, LA 70586. Cell (337) 831-1401. Email: [dell@desskay.com](mailto:dess@desskay.com)

## MISSISSIPPI

RHEAMS, TOMMY (State Director) 102 Lake Place Circle, Lumberton, MS 39455. Cell (601) 794-7104 Email: [tomrheams@aol.com](mailto:tomrheams@aol.com)

DEWEASE, STEVE. (National Director) 375 Baker Rd. Purvis, MS 39475 Cell (601) 794-7177. Email : [steved1976@yahoo.com](mailto:steved1976@yahoo.com)

GREENLEE, KEITH. (National Director) 2045 Hwy 13 N, Columbia MS 39429. Cell: (601) 441-2871. Email: [kgreenlee@dunganeng.com](mailto:kgreenlee@dunganeng.com)

WILLIAMSON, J.J. (National Director) 274 George Speed Rd., Collins, MS 39428. Cell: (601) 765-3558; Email: [jncw1964@yahoo.com](mailto:jncw1964@yahoo.com)

## **NORTH CAROLINA**

WRENN, CAREY (State Director) 190 Sage Lane, Madison Heights, VA 24572. Cell (434) 942-4992. Email: [NCDYB@dybusa.org](mailto:NCDYB@dybusa.org)  
HARDISON, JAY (National Director) 236 Bayside Road, Dunn, NC 28334. Home (910) 916-0033. Email: [jhardison@sttxna.com](mailto:jhardison@sttxna.com)  
JACKSON, DAVID (National Director) 609 Armory Rd., Parkton, NC 28371. Cell (910) 703-5649. Email: [wolfpackjack@aol.com](mailto:wolfpackjack@aol.com)  
WEST, ROY (National Director) 250 Canecutter Road, Lumberton, NC 28358. Home (910) 734-6961. Email: [rwest226@gmail.com](mailto:rwest226@gmail.com)

## **SOUTH CAROLINA**

MCCULLOCH, PAUL (State Director) 685 Heartwood Drive, Conway, SC 29526 Cell (843) 424-6722. Email: [SCDYB@dybusa.org](mailto:SCDYB@dybusa.org)  
BENNETT, JAY (National Director) 102 Nettles Park Road, Clemson, SC 29631. Business (864) 624-1122 Email: [jbennett@cityofclemson.org](mailto:jbennett@cityofclemson.org)  
PARNELL, PHIL (National Director) 155 Haynsworth Street, Sumter, SC 29150 Cell (803) 968-2320, Business (803) 436-2448, Fax (803) 436-2400  
E-mail: [pparnell@sumtercountysc.org](mailto:pparnell@sumtercountysc.org)  
WAGNER, GLEN, (National Director) PO Box 431, Dillon, SC 29536. Phone: Cell (843) 841-7075. Email: [gwdillon@bellsouth.net](mailto:gwdillon@bellsouth.net)

## **TENNESSEE**

REED, ALAN (State Director) 103 Creekview Circle, Rockwood, TN 37854. Cell (865) 742-5158. Email: [awreed@comcast.net](mailto:awreed@comcast.net)  
BROWN, TONY (National Director) 209 Suzanne Place, Kingston, TN 37763. Cell (865) 466-0294. Email: [tony.brown@roanecountytn.gov](mailto:tony.brown@roanecountytn.gov)  
VACANT (National Director)  
RUDOLPH, DON (National Director) 28 Adams Lane, Waverly, TN 37185. Home (931) 296-7203. Email: [tndybsd2010@yahoo.com](mailto:tndybsd2010@yahoo.com)

## **TEXAS**

SKELTON, WES (State Director) P O Box 877, Marshall, TX 75671. (903) 927-2255. Cell (903) 926-0400 Email: [texas@dixie.org](mailto:texas@dixie.org)  
COOK, KENNY (National Director) 3396 Bethlehem Rd. Lufkin, TX 75904 Cell (936) 674-8812. Email: [kennycook@yahoo.com](mailto:kennycook@yahoo.com)  
MITCHELL, JASON (National Director) P O Box 991, Center, TX 75935. Cell (936) 488-2863 Email: [j32mitchell@netzero.com](mailto:j32mitchell@netzero.com)  
SANDERS, BILL (National Director) 3775 Eagle Bend Drive, Paris, TX 75462 Phone: (903) 517-6593. Email: [wdsanders@suddenlink.net](mailto:wdsanders@suddenlink.net)

## **VIRGINIA**

EDWARDS, DD (State Director) 55 Winfrey Inez Rd., Dillwyn, VA 23936 Cell (434) 391-4843 Email: [volsknightsfan21@yahoo.com](mailto:volsknightsfan21@yahoo.com)

BOGGS, TIM (National Director) 3688 South Amherst Hwy, Madison Heights, VA 24572 Cell (434) 401-0021 Email: [tim@virginiaplaquesandtrophies.com](mailto:tim@virginiaplaquesandtrophies.com)

MARSHALL, BOBBY (National Director) 700 Old Court Street, Victoria, VA 23974 Cell (434) 321-2045 Email: [fyremarshall04@gmail.com](mailto:fyremarshall04@gmail.com)

SMITH, MIKE (National Director) 111 New Kent Dr., Goode, VA 24556. Home (540) 586-0124, Business (540) 587-6065, Fax (540) 587-6141.

Email: [msmith@bedfordva.gov](mailto:msmith@bedfordva.gov)

## **RETIRED BOARD MEMBERS**

BRITT, KENNETH, 8580 Old Lumberton Rd., Evergreen, NC 28438. Home (910) 648-4835 Email: [kjbears@intrstar.net](mailto:kjbears@intrstar.net)

HENRY, TOMMY, 3149 Telhurst Way, Buford, GA 30519

Cell: (678) 764-3357. Email: [TDHDYB@aol.com](mailto:TDHDYB@aol.com)

QUIGLEY, JIM, 24 Pipes Loop, Covington, LA 70435

Home (985) 893-1290. Email: [ellisquigley@charter.net](mailto:ellisquigley@charter.net)

SMITH, DAVID P.O. Box 189, Summit, MS 39666.

Cell (601) 248-4772. Email: [smittywayne@icloud.com](mailto:smittywayne@icloud.com)

### **SafeSport Act (Public Law 115-126)**

Visit our website for important information about league requirements to comply with the SAFESPORT ACT using the league DYB Child Protection Plan.

**DYBUSA.org**

### **Education Courses**

Visit our website for access to free online education and training courses emphasizing a culture of development, safety and fun focused on youth baseball players, coaches, and umpires.

**DYBUSA.org**

## DISTRICT DIRECTORS

### ALABAMA

Boster, Ken (District 1 Director) 1628 Woodview Drive SW, Hartselle, AL 35640,  
Cell (256) 214-4316, Email: [aladybd1@gmail.com](mailto:aladybd1@gmail.com)

Wood, Marcus (District 2 Director) 708 Almaroad Place, Jacksonville, AL 36265  
(256) 452-9765. Email [dist2dyb@gmail.com](mailto:dist2dyb@gmail.com)

Michaels, Kirby (District 3 Director) 15174 Green Circle, Northport, AL 35475. Phone:  
(205) 270-0596. Email: [kmichaels@psc1201.com](mailto:kmichaels@psc1201.com)

Douglass, Robert (District 4 Director) 1834 Hwy 31 North, Prattville, AL 36067.  
Cell (334) 220-6550, Email: [robertpdouglass@yahoo.com](mailto:robertpdouglass@yahoo.com)

Phaturos, Randy (District 5 Director) 69 Sage Brush Court, Millbrook, AL 36054.  
Phone: (334) 220-4021 Email: [jrphats@aol.com](mailto:jrphats@aol.com)

Speed, Jeff (District 6 Director) 2404 Stonewood Drive Dothan, AL 36301. Cell (334) 618-6976.  
Email: [aldybdistrict6@gmail.com](mailto:aldybdistrict6@gmail.com)

Patrick, Scott (District 7 Director) 6620 Henson Ct W, Mobile, Alabama 36695 (251) 423-2181  
Email: [cspatrick12@gmail.com](mailto:cspatrick12@gmail.com)

Keith, Tony (District 8 Director) 1989 Bellview Road, Henagar, AL 35978.  
Cell (256) 605-4285 Email: [tonykeith56@yahoo.com](mailto:tonykeith56@yahoo.com)

Carrington, Hal (District 9 Director) 1016 CO. RD. 222, Jack, AL 36346  
Cell: (334)379-0639 Email: [aldistrict9@gmail.com](mailto:aldistrict9@gmail.com)

Simmons, James (District 10 Director) 56 Blossom Circle, Tallassee, AL 36078  
(334) 640-1644 Email: [jasimmons24@gmail.com](mailto:jasimmons24@gmail.com)

Hicks, Gary (District 11 Director) 1908 Westmead Street SW, Decatur AL 35601;  
Phone: 256-410-0573; Email: [garyhicks9@gmail.com](mailto:garyhicks9@gmail.com)

### ARKANSAS

Casteel, Deral (District 2 Director) 270 Little Red River Mountain Road, Pangburn, AR  
72121 Cell: (501) 230-0041. Email: [deralcasteel@gmail.com](mailto:deralcasteel@gmail.com)

### FLORIDA

Cox, Brian (District 2 Director) 133 South 2nd Street, Wewahitchka, FL 32465. Phone: Home  
(850) 639-5066, Cell (850) 832-6009, Work (850) 639-3506.  
Email: [fldyb4@fairpoint.net](mailto:fldyb4@fairpoint.net)

Tate, Brock (District 3 Director) P O BOX 1007, Chipley, FL 32438  
Cell (850) 703-9946. Email: [btate@cityofchipley.com](mailto:btate@cityofchipley.com)

Glisson, Ray (District 4 Director) 11116 NW Faircloth Rd, Bristol, FL 32321  
Cell (850) 510-1372 Email: [libertyrecdep@gmail.com](mailto:libertyrecdep@gmail.com)

Arnold, Tim (District 5 Director) PO Box 872, Sneads, FL 32460. Phone: Home (850) 593-  
5497, Cell (850) 272-4143. Email: [timarnold270@yahoo.com](mailto:timarnold270@yahoo.com)

Molka, Jason (District 6 Director) 14155 Wake Robin Dr., Brooksville, FL 34604. Phone:  
Home (352) 584-8017. Email: [jason.shdb@gmail.com](mailto:jason.shdb@gmail.com)

Predmore, Brandy (District 7 Director) 404 Grimes Drive, Auburndale, FL 33823. Phone:  
Cell (352) 206-5231. Email: [brandypredmore@gmail.com](mailto:brandypredmore@gmail.com)

Buice, Charissa (District 8 Director) 145 Washington Blvd., Lake Placid, FL 33852.  
Cell (863) 214-9566. Email: [charissairene@gmail.com](mailto:charissairene@gmail.com)

Stallings, Denise (District 10 Director) 801 Longwood-Markham Rd., Sanford, FL 32771. Phone:  
Cell (407) 509-0492 Email: [denisestallings44@gmail.com](mailto:denisestallings44@gmail.com)

## GEORGIA

Fuller, Tangela (District 1 Director) 121 Perry St., Manchester, GA 31816 Phone: (706)846-3741  
Email: [tangelafuller@gmail.com](mailto:tangelafuller@gmail.com)

Kelley, Joshua (District 2 Director) 1350 Gunters Mill Road, Byron GA 31008 Cell (478)  
365-3836. Email: [jkellydyb@gmail.com](mailto:jkellydyb@gmail.com)

Colbert, Cheri (District 3 Director) 179 Mica Rd, Yatesville, GA 31097.  
Phone: (770) 584-4814 Email: [cheridyb2@yahoo.com](mailto:cheridyb2@yahoo.com)

Usry, Brian M. (District 4 Director) 1283 Brewton Dr, Stapleton, GA. 30823.  
Phone: (706) 831-4971. Email: [rbusry@yahoo.com](mailto:rbusry@yahoo.com)

Fain, Billy (District 5 Director) 6438 Eddie Lynn Rd. Donalsonville, GA. 39845 Phone:  
Cell (229) 400-1304. Email: [director@seminolerecreations.com](mailto:director@seminolerecreations.com)

## LOUISIANA

Roth, Brad (District 2 Director) 6921 Saints Drive, Metairie, LA 70003.  
Cell: (504) 736-6999 Email: [broth@jeffparish.net](mailto:broth@jeffparish.net)

Thomas, Seth (District 3 Director) 1502 Chestnut Dr., Morgan City, LA 70380. Home  
(985) 384-8608, Business (985) 380-4600, Cell (985) 312-4373.  
Email: [s.thomas@cityofmc.com](mailto:s.thomas@cityofmc.com)

Haynes, Jeff (District 4 Director) 140 Sanders Rd, Minden, LA 71055. Phone: Cell (318)  
465-1938, [Stantonhaynes@yahoo.com](mailto:Stantonhaynes@yahoo.com)

Drake, Johnny (District 5 Director) 2307 Swiss Street, West Monroe, LA71291. Phone:  
(318) 350-9700 Email: [jcdrake4@gmail.com](mailto:jcdrake4@gmail.com)

Berthelot, Gilly (District 6 Director) 909 E Cornerview Rd., Gonzales, LA 70737. Phone:  
Home (225) 647-5479, Business (225) 647-1326, Fax (225) 647-1326. Email:  
[jgberthelot@eatel.net](mailto:jgberthelot@eatel.net)

Deville, Eric (District 7 Director) 3864 L'Anse Bleu Road, Ville Platte, LA 70586  
Phone (337) 459-5550 Email: [LADYBDistrict7@gmail.com](mailto:LADYBDistrict7@gmail.com)

Valentine, Donnie (District 8 Director) 203 N. Abel Street, Winnfield, LA 71483. Phone:  
(318) 758-1992. Email: [donnievalentine1967@gmail.com](mailto:donnievalentine1967@gmail.com)

## MISSISSIPPI

Woods, Chris (District 2 Director) 60171 Hatley Rd. Amory, MS 38821. Phone:  
Cell: (662) 610-3616. Email: [cwoods22@maxxsouth.net](mailto:cwoods22@maxxsouth.net)

Ables, Todd (District 3 Director) 17295 Williamsville Rd, Kosciusko, MS 39090. Phone:  
Business (662) 582-0661, Cell (662) 416-2690. Email: [tables2424@gmail.com](mailto:tables2424@gmail.com)

Dykes, Frank (District 5 Director) 161 Magnolia Rd, Laurel, MS 39443. Phone: Cell  
(601) 433-5577. Email: [msdistrict5dyb@gmail.com](mailto:msdistrict5dyb@gmail.com)

Jenkins, Chuck (District 6 Director) 1592 Berwick Cassels Rd, Liberty, MS 39645.  
Cell (601) 946-0064. Email: [charles.jenkins@enbridge.com](mailto:charles.jenkins@enbridge.com)

Vacant (District 8 Director)

## **NORTH CAROLINA**

Thompson, Henry (District 1 Director) 499 White Smith Rd., Pittsboro, NC 27312. Home (919) 663-0800, Cell (919) 214-1263. Email: [henrythompson591@gmail.com](mailto:henrythompson591@gmail.com)

Burney, Frankie (District 2 Director) 4979 Burney Ford Rd., Clarkton, NC 28433. Cell (910) 874-4488. Email: [Frankie@intrstar.net](mailto:Frankie@intrstar.net)

Dellinger, Tony (District 3 Director) 3387 Maiden Hwy, Lincolnton NC 28092 Phone: (704) 240-0007. Email: [tony12157@charter.net](mailto:tony12157@charter.net)

Deason, Tug (District 4 Director) PO Box 279 Stanley, NC 28164. Phone: Cell 980-522-6769 Email: [tdeason@townofstanley.org](mailto:tdeason@townofstanley.org)

Lanning, Terry (District 5 Director) 3435 Horse Branch Rd., Watha, NC 28478. Phone: (910) 604-1644 Email: [Tbl112456@gmail.com](mailto:Tbl112456@gmail.com)

Mobley, Glenn (District 7 Director) 130 John Mobley Ln., Wallace, NC 28466. Phone: Business (910) 382-1206. Email: [nccoach81@gmail.com](mailto:nccoach81@gmail.com)

Vernon, Terry (District 8 Director) 1218 Forest Road, Eden, NC 27288. Phones: Home (336) 623-7630, Business (336) 623-7789, Ext. 3026, Cell (336) 280-5677. Email: [tvernon@edennc.us](mailto:tvernon@edennc.us)

Newkirk, Carl (District 9 Director) 2927 US Hwy 701 N, Elizabethtown, NC 28337. Phone: Home (910) 862-4460. Email: [oneyeimp@yahoo.com](mailto:oneyeimp@yahoo.com)

Hardison, Jay (District 11 Director) 236 Bayside Rd, Dunn, NC 28334. Phone: Home (910) 892-7829, Cell (910) 916-0033. Email: [jhardison@sttxna.com](mailto:jhardison@sttxna.com)

## **SOUTH CAROLINA**

Lance, Joey (District 1 Director) 306 Anderson Street, Belton, SC 29627. Phone: Business (864) 338-8832, Cell (864) 617-9345. Email: [jlance@cityofbeltonsc.com](mailto:jlance@cityofbeltonsc.com)

Peeler, Edward (District 2 Director) 135 Aiken Ct., Pauline, SC 29374 Home (Cell) (864) 909-9663, Business (864) 949-1111 Email: [epandap@aol.com](mailto:epandap@aol.com)

Polson, Rickey (District 3 Director) 1331 Sunset Blvd., Clinton, SC 29325 Home (864) 833-6639, Business (864) 422-4641, Cell (864) 684-3028. Email: [rickeypolson@bellsouth.net](mailto:rickeypolson@bellsouth.net)

Miller-Ostrom, LaDonna (District 4 Director) 532 Kitti Wake Dr., West Columbia, SC 29170. Cell (803) 451-1494. Email: [dixieyouthdiva@hotmail.com](mailto:dixieyouthdiva@hotmail.com)

Adams, Tim (District 5 Director) 710 S Wilson Dr., Cheraw, SC 29520. Phone: Home (843) 537-6071, Office (843) 287-4114, Fax (843) 537-8423. Email: [timadams627@gmail.com](mailto:timadams627@gmail.com)

Taylor, Shawn (District 6 Director) 367 Green Street, Orangeburg, SC 29115. Office (803) 533-6020 Fax (803) 533-6027 Cell: (803) 387-8339 Email: [shawn.taylor@orangeburg.sc.us](mailto:shawn.taylor@orangeburg.sc.us)

Stewart, Daniel (District 7 Director) 3100 Mabeline Road Hanahan, SC 29410 Phone: (843) 266-0723. Email: [dstewart@cityofhanahan.com](mailto:dstewart@cityofhanahan.com)

Watts, Matt (District 8 Director) 905 Buckwalter Pkwy, Bluffton, SC 29910. Cell (843) 812-7929. Email: [mwatts@bcgov.net](mailto:mwatts@bcgov.net)

Graham, Ryan (District 9 Director) 155 Haynsworth Street, Sumter, SC 29150. Phone: Cell (803) 464-1487 Fax (803) 436-2400. Email: [rgraham@sumtercountysc.org](mailto:rgraham@sumtercountysc.org)

Hudson, David (District 10 Director) 3005 Sally Circle, Florence, SC 29501. Phone: Cell (843) 206-5069. Email: [hudsond393@gmail.com](mailto:hudsond393@gmail.com)

Vacant (District 11 Director)

## TENNESSEE

Dorris, Phillip (District 1 Director) 120 Old Hwy 52 East, Portland, TN 37148 Phone: (615) 715-2926 Email: [dorrisfourvolts@gmail.com](mailto:dorrisfourvolts@gmail.com)

Neisler, Mike (District 2 Director) 280 Marvin Terry Lane, Henderson, TN 38340. Phone: Cell (731) 697-7554 Email: [mneisler672@gmail.com](mailto:mneisler672@gmail.com)

Lineberry, Denise (District 3 Director) P.O.Box 152, Clifton, TN 38425. Home (731) 926-1555 Cell (731) 607-1614 Email: [deniselinberry@hotmail.com](mailto:deniselinberry@hotmail.com)

Osborne, Rory (District 4 Director) 790 W College Street, Greenbrier, TN 37073 Phone (615) 642-8611. Email: [rosborne@greenbriertn.org](mailto:rosborne@greenbriertn.org)

Tidwell, James M. (District 5 Director) 6170 Terrapin Hollow Rd., Lyles, TN 37098. Phone: Home (931) 670-3842, Cell (931) 623-5076. Email: [jamestidwell120@gmail.com](mailto:jamestidwell120@gmail.com)

Vacant (District 6 Director)

Conrad, David (District 7 Director) 485 Oak Hill Drive, Sweetwater, TN 37874. Phone: Cell (423) 253-5375 Email: [davidconrad5375@gmail.com](mailto:davidconrad5375@gmail.com)

French, Megan (District 8 Director) 176 Newport Way, Kingston, TN 37763 865-224-0440 Email: [tdist8dyb@gmail.com](mailto:tdist8dyb@gmail.com)

## TEXAS

Kane, Chris (District 1 Director) P O Box 692, Howe, TX 75459 Cell: (903) 818-2322 Email: [chriskane2010.ck@gmail.com](mailto:chriskane2010.ck@gmail.com)

Garland Hawk (District 2 Director) 420 Edgewood Circle, Lufkin, TX 75904; Cell 936-674-8812; Email: [ghawk@consolidated.net](mailto:ghawk@consolidated.net)

Bates, Chris (District 3 Director) 704 East Avenue D, Hooks, TX 75561. Phone: Cell (903) 319-1010. Email: [hometbates@gmail.com](mailto:hometbates@gmail.com)

Miller, Terry (District 4 Director) PO Box 3332, Longview, TX 75606 Cell (903) 452-3161. Email: [terrydmiller11@gmail.com](mailto:terrydmiller11@gmail.com)

Green, Ronald (Asst. District 5 Director) 432 CR 34440, Sumner, TX 75486 Cell: (903) 272-4838. Email: [rrgreen@hotmail.com](mailto:rrgreen@hotmail.com)

Reece, Lemone (District 6 Director) P O Box 1087 Palestine, TX 75802. Cell (903) 391-2799. Email: [lemone@dybusa.org](mailto:lemone@dybusa.org)

Cumberland, Bo (District 7 Director) 1131 Mulberry Lane, Dayton, TX 77535. Phone: Cell/Home (936) 402-8396. Email: [bcbo49@gmail.com](mailto:bcbo49@gmail.com)

Karns, Marty (District 9 Director) 294 CR785 Douglass, TX 75943. Phone: Cell (936) 371-9819. Email: [marty\\_karns1@yahoo.com](mailto:marty_karns1@yahoo.com)



## VIRGINIA

Soles, Bryan (District 2 Director) 423 E. Ferrell Street, South Hill, VA, 23970 Phone: (434) 210-0161 Email: [bryansoles@meckelec.org](mailto:bryansoles@meckelec.org)

Vacant (District 3 Director)

Price, Adam (District 4 Director) 155 Ridge Lane, Scottsville, Va. 24590  
Cell: (434)962-2966 Email: [adampriceeng@gmail.com](mailto:adampriceeng@gmail.com)

Norton, Wayne (District 5 Director) 1002 Woodmens Road, Crewe, VA 23930.  
Home (434) 767-4802, Fax: (434) 767-4802, Cell (434) 294-8068. Email: [farmerchamp@yahoo.com](mailto:farmerchamp@yahoo.com)

Lee, Tim (District 6 Director) PO Box 86, Naruna, VA 24576. Phone: Home (434) 509-9914, Cell (434) 665-6153. Email: [twlee@bwxt.com](mailto:twlee@bwxt.com)

Tice, Erin (District 7 Director) 6461 Bradshaw Road, Salem, VA 24153. Phone: Cell (540) 798-3530. Email: [etice1256@gmail.com](mailto:etice1256@gmail.com)

Eley, Rob (District 9 Director) P.O. Box 68, Prince George, VA23875.  
Phone: (804) 586-9846. Email: [reley@princegeorgecountyva.gov](mailto:reley@princegeorgecountyva.gov)

### YOUR DISTRICT DIRECTOR—YOUR SERVICE MANAGER

*Every person who serves as an elected official of DYB is elected to SERVE the leagues. This is the one and only reason he holds office. Each league, therefore, is encouraged to take advantage of the services offered by each official. The District Director is generally the nearest official and certainly the most informed on matters dealing with a league and its need. We strongly suggest that league officials use the services offered by their District Director as their first move in obtaining help. Naturally, the State and National Directors from their state also stand ready to help, if needed. The Commissioner is also available to help.*

*Portions of the Official Baseball Rules appearing in this rule book have been reprinted by special permission of the Office of the Commissioner of Baseball. The copyright in the Official Baseball Rules is owned and has been registered by the Commissioner of Baseball. Any additional material contained in this book has not been endorsed by the Commissioner of Baseball.*

## **Operational and Non-Operational Control by Dixie Youth Baseball for Liability Purposes**

**1. As concerns all pre-season activities; regular season; intra-league tournaments; and all other league activities; Dixie Youth Baseball®, Inc., shall have no operational control responsibility over the following:**

(a) **Premises**—including, but not limited to, playing fields, practice fields, player dugouts, spectator areas, concession areas, parking lots, adjoining areas, and player or spectator entertainment areas whether on site or off site.

(b) **Activities**—including, but not limited to, preseason and off-season meetings and preparation, "implementation of a child abuse/molestation risk management program, player registration tryouts, practices, games, intra-league tournaments, fundraising activities, banquets, team or league outings and all other activities that are team or league approved and travel to and from the above.

(c) **Actions**—including all actions (including inactions) and decisions on a league or team level that are initiated by league or team officials, directors, administrators or volunteers, including the selection of volunteers and league security.

**2. As concerns sanctioned all-star tournaments including subdistrict, district, area, regional, state, and world series, Dixie Youth Baseball®, Inc., shall have no operational control or responsibility over the following:**

(a) **Premises**—including, but not limited to, practice areas, spectator areas, concession areas, player accommodations, and player or spectator entertainment areas whether on site or off site.

(b) **Activities**—including, but not limited to, activities within housing, player or spectator entertainment on site or off site, outings, and travel to and from the above.

(c) **Actions**—including all actions (including inactions) or decisions initiated by the tournament host or by team volunteers or employees, including the selection of volunteers and tournament security.

3. (a) Dixie Youth Baseball has operational control and responsibility only to the extent of requiring that any violation of official rules and regulations be corrected in accordance with the official rules and regulations.

(b) Dixie Youth Baseball has joint operational control and responsibility with the tournament host over all game playing fields and dugout areas for all-star tournaments including subdistrict, district, area, regional, state and world series.

4. Dixie Youth Baseball is primarily an "all-volunteer" organization with limited resources, it is not responsible for taking affirmative action to police all premises, activities, and actions for compliance with the official rules and regulations, except as outlined under 3. (b) above. However, Dixie Youth Baseball will make best efforts to enforce all such official rules and regulations once a violation has been brought to its attention.

# DATES TO REMEMBER

**JANUARY – FEBRUARY – 2022 State Meetings Scheduled** – See schedule on DYB website at DYBUSA.org under State Websites tab.

## MARCH

**1–Deadline for DYB scholarship applications.**

## APRIL

1–Latest date for submitting Annual Billing for Franchise Fees form and applicable fees online or by postmarked mail to DYB to renew franchise privileges. **FAILURE TO COMPLY WILL RESULT IN A LATE FEE OF \$50.00.** Late fees will be donated to the DYB Scholarship Fund

1–Deadline for letters of intent to bid on a 2024 DYB World Series

## MAY

1–Scholarship winners announced no later than this date

1–Leagues must submit all “O” Zone, AAA, AA and A rosters online for review by the District and State Director.

1–Deadline for selection of sub-district, district, & State Tournament sites

15–Deadline for nominating National Board of Directors and State Directors.

## JUNE

1–Deadline for submission of proposed rule & policy changes to Deputy Commissioner

1- District Directors shall notify leagues of the date and location of the District Credentials Meeting on or before this date

1–Deadline for selection of sub-district, district, & State Tournament sites

1–Deadline for distributing online ballots for election of National Board Members and State Directors

10–Deadline for submitting ballots in National Board and State Directors elections

## JULY

18 – All state tournaments completed by this date

28 – Division II Majors, “O”Zone, AAA, World Series begins – Anderson, South Carolina

28 – Division I & II AA World Series begins. Dothan, Alabama

## AUGUST

6-11 – DYB Division I “O Zone”, Majors, AAA World Series- Lumberton, North Carolina

6-9 – Board of Directors’ Annual Meeting



Suggested Guide for Construction of DYB 60' Baseline Playing Field.  
 See Official Rules for Exact Dimensions for Each Section of Playing Field in Current Rule Book.

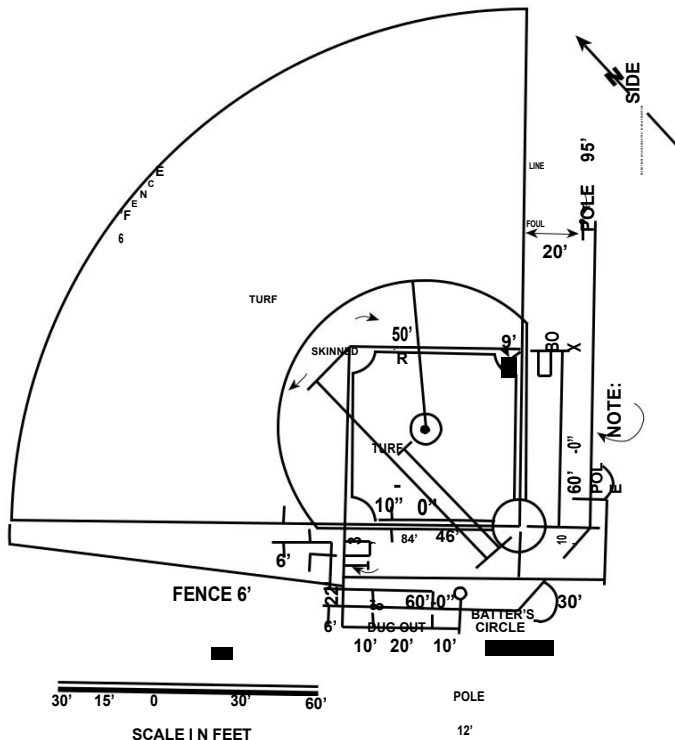

**NOTE**—The base runner's path on the first base line shall be three (3) feet outside of the foul line and shall begin thirty (30) feet from home plate and extend to the direction of first base (parallel to foul line).

*For any new field constructed, it is recommended that foul lines be a minimum of 160 feet and a maximum of 200 feet for the A and AA Divisions; a minimum of 200 feet and a maximum of 225 feet for the Majors and AAA Divisions; and, a minimum of 225 feet and maximum of 250 feet for the "O" Zone Division.*

## LEGEND

- A—1st, 2nd, 3rd Bases
- B—Batter's Box
- C—Catcher's Box
- D—Home Plate
- E—Pitcher's Mound

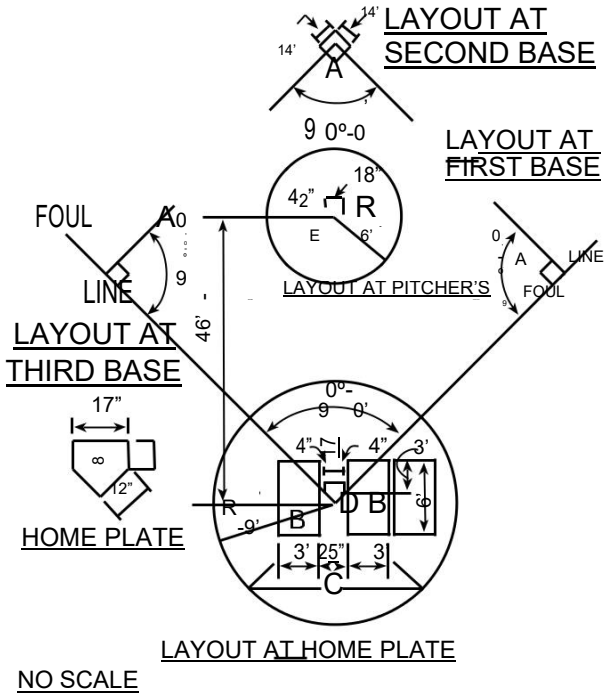

## DETAILS OF BATTER'S BOX

# Dixie Youth Baseball<sup>®</sup>, INC. OFFICIAL PLAYING RULES

## 1.00—OBJECTIVES OF THE GAME

1.01—Dixie Youth Baseball Inc. (“DYB”) is a game between two teams of nine players each, ages twelve and under, under direction of a manager, played on a regulation DYB playing field in accordance with these rules, under jurisdiction of one or more umpires.

1.02—The objective of each team is to win by scoring more runs than the opponent.

1.03—The winner of the game shall be that team which shall have scored, in accordance with these rules, the greater number of runs at the conclusion of a regulation game.

1.04—**THE PLAYING FIELD.** The playing field shall be laid out as follows:

(a) The length of the baselines shall be:

A Division - (T-Ball) fifty feet (50’) in distance forming a 50-foot square; AA, AAA, and Majors Divisions - sixty feet (60’) in distance forming a 60-foot square; and “O” Zone Division - seventy feet (70’) in distance forming a 70-foot square.

(b) The distance from the front side of the pitching slab to the point of home plate shall be:

**AA, AAA, and Majors Divisions - forty-six feet (46’) in distance;**

**“O” Zone Division - fifty feet (50’) in distance.**

(LOCAL LEAGUE OPTION) Local leagues may use a 46’, 48’, or 50’ pitching distance in local league play only.

(LOCAL LEAGUE OPTION) Local leagues may use a 43’ for AA pitching distance for player pitchers in local league play only.

(c) The distance from the point of home plate to the center of second base and from first base to third base shall be:

AA, AAA, and Majors Divisions - eighty-four feet ten inches (84’10”) and “O” Zone Division - ninety-nine feet (99’0”).

The distance from the point of home plate to the backstop is recommended to be (25’) twenty-five feet. (Minimum of (20’) twenty feet.)

(d) The minimum distance from home plate to the nearest outfield fence shall be:

AA & A Divisions - 160 feet

Majors & AAA Divisions - 200 feet with a maximum of 225 feet and a minimum outfield fence height of six (6) feet.

“O” Zone Division – 225 feet with a maximum of 250 feet and a minimum outfield fence height of six (6) feet.

NOTE: Fields used for World Series play must meet the minimum requirements.

(e) The batter’s box shall be six feet (6’) long and three feet (3’) wide.

(f) The catcher’s box shall be the foul lines extended nine feet (9’), with the points then joined.

(g) The base runner’s path on the first base line shall be three feet (3’) outside of the foul line and shall begin thirty feet (30’) from home plate and extend parallel to the foul line to first base.

(h) The grass line, where the dirt of the infield ends and the grass of the outfield begins should be a 50’ (65’-“O”Zone) radius from the center of the pitching mound.

(i) Lighted fields shall have adequate lighting approved by a DYB official.

1.05–Home plate shall be 17 inches long on the edge nearest the pitcher’s mound and shall be 17 inches from this side to the back point. The two sides shall be 8½ inches long before they angle to the back. Construction shall be of white rubber, with black beveled apron, and spikes may be permanent or removable. Construction shall provide maximum protection in design.

1.06 –Bases shall be of material of the league’s own choice (cloth or rubber) but shall be of official size 14 inches by 14 inches by 2¼ inches maximum. Bases may be anchored by straps to spikes or by Hollywood type anchors.

1.07 –The pitcher’s plate shall be a rectangular slab of white rubber, 18 inches by 4 inches, and shall be placed at an elevation of 6” above the level of home plate. It shall be set in the ground as specified below, so that the distance between the front edge of the pitcher’s plate and home base (the back point of home plate) shall be 46 feet (50 feet for “O” Zone Division). NOTE: Portable mounds may be used in tournament play.

### **Pitching Mound Specifications:**

(a) Pitching Mound—A twelve-foot (12’) diameter circle, the center of which is 45 feet (49 feet for “O” Zone Division) from the back point of home plate.

(b) The front edge of the pitcher’s plate shall be located twelve inches (12”) behind the center of the pitching mound.

(c) The distance between the front edge of the pitcher’s plate and the back point of home plate shall be 46 feet (50 feet for “O” Zone Division).

(d) A level area surrounding the pitcher’s plate shall be six inches (6”) in front of the rubber, eighteen inches (18”) to each side of the rubber and twenty-four inches (24”) behind the rubber. The total level area shall be four and one-half feet (4½’) by thirty-four inches (34”).

(e) The degree of slope from a point six inches (6”) in front of the pitcher’s plate to a point six feet toward home plate shall be one inch (1”) to one foot (1’). The slope shall be uniform. **EXCEPTION:** Portable mounds with a minimum level area surrounding the pitcher’s plate of four and one-half feet (4½’) by thirty-four inches (34”) and a slope of 1.6” to 1’ are acceptable for regular season and tournament play. (LOCAL LEAGUE OPTION) The local league may elect to use a pitcher’s plate of white rubber six inches (6”) by twenty-four inches (24”) which is placed at an elevation of six inches (6”) above the level of home plate. The front edge of the pitcher’s plate shall be located twelve inches (12”) behind the center of the pitching mound. The total level area shall be five feet (5’) by thirty-six inches (36”).

1.08–The league shall furnish players’ benches, one each for the home and visiting teams. Each bench should not be less than twenty-two feet (22’) from the base lines. Each bench should be roofed and should be enclosed at the back and ends.

1.09–(a)The ball shall be a sphere formed by yarn wound under consistent tension around a small core center of cork or rubber weighing 7/8 ounces avoirdupois and covered with two elongated figure-eight-shaped strips of white horsehide or cowhide, tightly stitched together in seams with 108 double stitches into each baseball, with the first and last stitches completely hidden. The ball shall weigh between 5 and 5 1/4 ounces, avoirdupois (141.75 to 148.83 g) The ball shall measure between 9 - 9 1/4 inches (228.60–234.95 mm) in circumference and 2.86–2.94 inches (72.64–74.68 mm) in diameter. (LOCAL LEAGUE OPTION)-A synthetic or leather covered stitched baseball meeting the specifications below is allowed in local league play.

(b) Only baseballs bearing the mark or other certification which indicates that the ball meets DYB specifications shall be used in any regular season game. Leagues may use blemished baseballs provided they meet DYB specifications in (a) and (b) above and are stamped as officially approved for “Local League Play Only.” Any games played using baseballs that do not bear the above approvals will not be official games and will not count in league standings.

(c) An official DYB baseball meeting the specifications in paragraphs (a) and (b) above and bearing the signature of the Commissioner shall be used in all tournament games. Manufacturing specifications are available from the Commissioner.

### **Approved Bats**

**1.10–(a)** The barrel of all aluminum, metal alloy, composite, multi-piece wood bats or single-piece wood bats shall not exceed 2 5/8” inches in diameter nor exceed 33” inches in length.

**1.10–(b) (1) USA Baseball Bats** - All non-wood bats and multi-piece wood bats must be stamped with the USA Baseball mark signifying that the bat meets the bat performance standard established by USA Baseball. USA Baseball is the national governing body of amateur baseball in the United States.

(2) **Wood Bats** - Solid wood bats made from a single piece of wood do not require the USA Baseball mark but must meet the specifications in Rule 1.10(a).

(3) **BBCOR Bats** - 2 5/8” BBCOR (-3) certified bats (*which do not bear the USA Baseball mark*) that meet the Batted Ball Coefficient of Restitution (BBCOR) standard and which do not weigh, numerically, more than three ounces less than the length of the bat (**e.g., a 33-inch-long bat cannot be less than 30 ounces**) may be used in regular season or tournament play.

(4) All bats stamped “BPF 1.15” are not legal for play in all age divisions.

**1.10–(c) Tee Ball Bats** – Tee Ball bats will be stamped with the USA Baseball Mark and the language “Only for use with approved tee balls”. Bats stamped for Tee Ball (T-Ball) play can only be used with low compression balls due to the manufacturing standards for these bats. Any bat stamped for Tee Ball (T-ball) play **cannot** be used in games played using a regular baseball that is pitched to the batter in any division of DYB.

**1.10(d) Illegal Bat Penalty:** A bat which does not meet the specifications in Rule 1.10(a) and Rule 1.10(b) shall be deemed an illegal bat. A batter who uses an illegal bat shall be called out and all runners shall return to the bases occupied by them at the time such batter took his position in the batter’s box if protested by the opposing team manager prior to the first pitch to the next batter. A batter uses a bat when he takes the first pitch from a pitcher during any time at bat. The bat becomes illegal when the batter receives the first pitch during his turn at bat. The ball does not have to be hit. The batter will be called out and any runners must return to the base they occupied prior to the first pitch to the batter.

1.11(a)–Players may wear any type clothing in local league play approved by the League including shoes. (**NOTE:** A pitcher shall not wear a shirt with long white sleeves). Players regular season uniforms shall include any “official” embroidered emblem(s) issued by DYB on the left shoulder. **The “official” embroidered emblem(s) must be used on tournament uniforms.** Local League Option: A local league may screen print the emblem on regular season uniforms only.



(b) Players or other personnel on the field, including managers, coaches, umpires, bat boys, etc., shall not wear shoes with cleats (molded or screw-on) that contain any metal materials.

(c) Defensive players may wear sunglasses.

(d) Players on the field or in the dugout area shall not wear jewelry of any kind, for safety reasons. This includes bracelets, necklaces and piercings of any kind. **EXCEPTION:** Players may wear breakaway sports necklaces. Medical or religious tags or medallions may be worn and secured by tape if deemed necessary by the umpire-in-chief. **PENALTY:** When a first-time occurrence is noted, a warning shall be given to both teams, which applies to all players. Upon the second occurrence, the manager and player(s) will be ejected from the game.

1.12 –The first baseman may wear a glove or mitt not more than 12 1/2 inches long from top to bottom and not more than eight inches wide across the palm, measured from the base of the thumb crotch to the outer edge of the mitt. The glove may be of any weight. **PENALTY:** For violation of rule 1.12, the illegal equipment must be removed from the game.

1.13 –Each fielder, other than the first baseman and the catcher may wear a glove not more than 12 1/2 inches long nor more than 7 3/4 inches wide, measured from the base of the thumb crotch to the outer edge of the glove. The glove may be of any weight. **PENALTY:** For violation of rule 1.13, the illegal equipment must be removed from the game.

1.14 –(a) The pitcher’s glove may be of a contrasting color, including all stitching, lacing and webbing. The pitcher’s glove may not, exclusive of piping, be white or gray, nor, in the judgment of an umpire, distracting in any manner.

(b) No pitcher shall attach to the glove any foreign material of a color different from the glove. **PENALTY:** For violation of rule 1.14, the illegal equipment must be removed from the game.

## **Batters Helmets**

1.15 –(a) The batter’s helmet shall be made of Ultra High Impact Plastic or High Impact Plastic Shell. The shell shall be made of one-piece construction or two pieces if they snap into a single unit similar to the one-piece construction type. The helmet shall have pieces for ears and full protection for the head and temple. The padding shall be of heavy rubber or similar material. **State Option:** State organizations may require chin straps for batter’s helmets.

(b) An offensive player shall not remove his helmet while on the playing field, such as a bat boy, on-deck batter, batter, base runner or player base coach. **PENALTY:** For a first offense the player shall be warned by the umpire; for second and subsequent offenses in the same game, the player shall be called out. If the violation is by a bat boy, on-deck batter, or player base coach the penalty for their second offense is removal from game and from the field.

(c) A face guard may be used on a batter’s helmet but must be properly installed according to manufacturer’s specifications. The face guard becomes a permanent part of the helmet. **State Option:** DYB state organizations may mandate all leagues within the state to use face guards on batter’s helmets for local league and tournament play. **Local League Option:** In absence of state requirements, leagues may require all players in specified age divisions to use face guards on batter’s helmets.

(d) Each league shall provide protective helmets which must meet DYB specifications and standards. Use of helmet by the batter, on-deck batter, all base runners and coaches is mandatory. Use of helmet by an adult base coach is optional. **NOTE:** The helmets provided by each league must meet NOCSAE specifications and bear the NOCSAE stamp as well as an exterior warning label as noted below.

### **WARNING!!**

**Manufacturers have warned that altering helmets in any way can be dangerous. Alterations of a helmet in any form, including painting, by anyone other than the manufacturer or an authorized dealer may void the warranty!**

### **Catcher's Equipment**

1.16 –(a) Each catcher must wear a catcher's helmet which meets the following requirements: The catcher's helmet shall be made of Ultra High Impact Plastic or High Impact Plastic shell with a heavy rubber padding or similar material. The helmet must be of such construction to either be a part of the catcher's mask or be firmly attached to the mask. The catcher's mask and helmet must cover the top of the head, temple and ears. (Catchers may not wear skull caps.) The hockey-style catcher's mask, if manufactured to meet the above requirements, is approved. All catcher's masks (excluding the hockey-style masks) must always have a hard-plastic throat protector as specified in paragraph 1.16(d) attached to the mask.

(b) Catcher's helmets are required to bear the NOCSAE seal of approval.

(c) The helmet must fit with a snug fit of the head and must be worn as intended by the manufacturer.

**(d) CATCHERS MUST WEAR A CATCHER'S MASK ATTACHED TO A HELMET AS DESCRIBED IN PARAGRAPHS (a)–(c) ABOVE. A HARD, PLASTIC PROTECTOR MANUFACTURED TO PROTECT THE THROAT SHALL BE SECURELY ATTACHED TO THE MASK EVEN IF THE MASK HAS AN EXTENSION AT THE BOTTOM EXCLUDING THE HOCKEY-STYLE MASK. (Homemade devices made from other pieces of equipment may not be used.)**

**(e) MALE CATCHERS MUST WEAR A PROTECTIVE CUP WITH SUPPORTER IN ALL GAMES. FEMALE CATCHERS MUST WEAR SUFFICIENT PROTECTIVE PADDING TO PREVENT INJURY.**

(f) The catcher must wear a catcher's mitt (not a first-baseman's mitt or fielder's glove) with shape, size or weight consistent with protecting the hand. **PENALTY:** For violation of rule 1.16(f), the illegal equipment must be removed from the game. The catcher's equipment, other than the items note above, may be the choice of the local league but needs to be of high quality and afford adequate protection.

(g) Any player warming up a pitcher on the mound, in a bullpen or elsewhere shall wear a catcher's mask with helmet and throat protector even if the mask has a manufactured extension at the bottom of the mask. A batting helmet cannot be used to warm up a pitcher. It is strongly recommended that only players warm up pitchers at any time during practice or regular season games. No other person should warm up a pitcher without a protective catcher's face mask due to the risk of substantial facial or head injury from deflected balls.

1.17 –(a) The local league shall select all other equipment used in the DYB program such as gloves, hats, uniforms, shoes and umpires' equipment.

(b)No softball equipment may be used in DYB play, including the softball catcher's mask, softball catcher's mitt, softball bats, and other equipment designed for softball play. **EXCEPTION:** The softball fielder's mask or any youth fielders mask may be used in all age divisions at all defensive positions if it is not labeled for softball use only and/or a baseball will not pass through the openings in the mask. (c)It is recommended that all male players wear athletic supporters. (d)The on-deck batter will use the on-deck batter's circle behind the batter that is at bat during a practice or a game unless the on-deck circle is behind a protective screen.

1.18 –No player wearing a hard substance in its final form such as leather, rubber, plastic, plaster or fiberglass when worn on the hand, wrist, forearm or elbow shall be allowed to participate unless the substance is covered by a minimum ½ inch thick, high-density closed-cell polyurethane or a similar material of the same thickness to protect injury. Written permission must be obtained from both a licensed medical physician and the player's parent or guardian and submitted to league president during local league play and the tournament director during tournament play for approval.

## 2.00—DEFINITION OF TERMS

(All definitions in Rule 2.00 are listed alphabetically)

**ADJUDGED** is a judgment decision by an umpire.

An **APPEAL** is an act of a fielder in claiming violation of the rules by the offensive team. An appeal must be made verbally. See rule 7.10 for runner appeal.

A **BACKSTOP** is the barrier erected behind the catcher in order to allow the catcher to retrieve passed balls easily.

**BALK: "O"ZONE BALK** is an illegal act by the pitcher or the catcher with a runner or runners on base, entitling all runners to advance one base. **TRADITIONAL BALK** is an illegal act by the pitcher which shall be declared a no pitch, the ball is dead, and no runners advance.

A **BALL** is a pitch which does not enter the strike zone in flight and is not struck at by the batter. [If the pitch touches the ground and bounces through the strike zone, it is a "ball". If such pitch touches the batter, he shall be awarded first base. If the batter hits such a pitch, the ensuing action shall be the same as if the batter hit the ball in flight.]

A **BASE** is one of four points which must be touched by a runner in order to score a run; more usually applied to the canvas bags and the rubber plate which mark the base points.

A **BASE COACH** is a team member or an adult manager or coach, who is stationed in the coach's box at first or third base to direct the batter and the runners.

A **BASE ON BALLS** is an award of first base granted to a batter, who during his or her time at bat receives four pitches outside the strike zone.

A **BATTER** is an offensive player who takes a position in the batter's box.

**BATTER-RUNNER** is a term that identifies the offensive player who has just finished a time at bat until that player is put out or until the play on which that player becomes a runner ends.

The **BATTER'S BOX** is the area within which the batter must stand during a time at bat.

The **BATTERY** is the pitcher and catcher.

**BENCH OR DUGOUT** is the seating facilities reserved for players, substitutes, and the manager and coaches when they are not actively engaged on the playing field.

A **BUNT** is a batted ball not swung at, but intentionally met with the bat and tapped slowly within the infield.

A **CALLED GAME** is one in which, for any reason, the umpire-in-chief terminates play.

A **CATCH** is the act of a fielder in getting secure possession in the hand or glove of a ball in flight and firmly holding it before it touches the ground providing such fielder does not use cap, protector, pocket or any other part of the uniform in getting possession. It is not a catch, however, if simultaneously or immediately following contact with the ball, the fielder collides with a player, or with a wall, or if that fielder falls, and as a result of such collision or falling, drops the ball. It is not a catch if a fielder touches a fly ball which then hits a member of the offensive team or an umpire and then is caught by another defensive player. If the fielder has made the catch and drops the ball while in the act of making a throw following the catch, the ball shall be adjudged to have been caught. In establishing the validity of the catch, the fielder shall hold the ball long enough to prove complete control of the ball and that release of the ball is voluntary and intentional. **COMMENT:** A catch is legal if the ball is finally held by any fielder, even though juggled, or held by another fielder before it touches the ground. Runners may leave their bases the instant the first fielder touches the ball. A fielder may reach over a fence, railing, rope or other line of demarcation to make a catch. He may jump on top of a railing, or canvas that may be in foul ground. No interference should be allowed when a fielder reaches over a fence, railing, and rope or into a stand to catch a ball. He does so at his own risk. If a fielder, attempting a catch at the edge of the dugout, is "held up" and kept from an apparent fall by a player or players of either team and the catch is made, it shall be allowed.

The **CATCHER** is the fielder who takes the position behind the home base.

The **CATCHER'S BOX** is that area within which the catcher shall stand until the pitcher delivers the ball.

**CHAMPIONSHIP GAMES** are playoff games played by two or more teams tied at the end of regular season play with identical won/loss records to determine a league champion; or, when applicable, first or second half winners to determine a league champion or playoff games between tied teams to determine first or second half winner. These are not scheduled regular season games but additional games required to determine a league champion or first or second half winner. They are not to be considered as tournament games and are to be played according to regular season rules with the exceptions provided in Rule 8.07 (f), (g), (h).

A **COACH** is one who assists the manager and whose name also appears on the Player Registration Form.

A **COMPLETE TIME AT BAT** begins when a player takes a position in the batter's box as a batter with a count of no balls and no strikes and ends when that player reaches base safely or is declared out.

A **DEAD BALL** is a ball out of play because of a legally created temporary suspension of play.

The **DEFENSE (or DEFENSIVE)** is the team, or any player(s), in the field.

**DOUBLE ELIMINATION** is the loss of two games by the same team in a single tournament at any level, i.e. area, sub-district, district, state, World Series.

A **DOUBLE PLAY** is a play by the defense in which two offensive players are put out as a result of continuous action, providing there is no error between putouts.

(a) A force double play is one in which both putouts are force plays.

(b) A reverse force double play occurs when the first out is made at any base and the second out is made on a runner for whom the force is removed by reason of the first out.

**DUGOUT** (see definition of “**BENCH**”).

A **FAIR BALL** is a batted ball that settles on fair ground between home and first base, or between home and third base, or that is on or over fair territory when bounding to the outfield past first or third base, or that touches first, second or third base, or that first falls on fair territory on or beyond first base or third base, or that, while on or over fair territory touches the person of an umpire or player, or that, while over fair territory, passes out of the playing field in flight. **COMMENT:** If a fly ball lands in the infield between home and first base, or home and third base, and then bounces to foul territory without touching a player or umpire and before passing first or third base, it is a foul ball; or if the ball settles on foul territory or is touched by a player on foul territory, it is a foul ball. If a fly ball lands on or beyond first or third base and then bounces to foul territory, it is a fair hit.

**NOTE:** A fair fly shall be adjudged according to the relative position of the ball and the foul line, including the foul pole, and not as to whether the fielder is on fair or foul territory at the time such fielder touches the ball.

**FAIR TERRITORY** is that part of the playing field within, and including the first base and third base lines, from home base to the bottom of the playing field fence and perpendicularly upwards. Home plate, first base and third base and all foul lines are in fair territory.

A **FIELDER** is any defensive player.

**FIELDER'S CHOICE** is the act of a fielder who handles a fair grounder and, instead of throwing it to first base to put out the batter-runner, throws to another base to put out a preceding runner. The term is also used by scorers (a) to account for the advance of the batter-runner who takes one or more extra bases when the fielder who handles the safe hit attempts to put out a preceding runner; (b) to account for the advance of a runner (other than by stolen base or error) while a fielder is attempting to put out another runner; and (c) to account for the advance of a runner made solely because of the defensive team's indifference (undefended steal).

A **FLY BALL** is a batted ball that goes high in the air in flight.

A **FORCE PLAY** is a play in which a runner legally loses the right to occupy a base by reason of the batter becoming a runner. **COMMENT:** Confusion regarding this play is removed by remembering that frequently the “force” situation is removed during the play. Example: Man, on first, one out, ball hit sharply to first baseman who touches the bag and batter-runner is out. The force is removed at that moment and runner advancing to second must be tagged. If there had been a runner on third or second, and either of these runners scored before the tag-out at second, the run counts. Had the first baseman thrown to second and the ball then had been returned to first, the play at second was a force out, making two outs, and the return throw to first ahead of the runner would have made three outs. In that case, no run would score. Example: Not a force out. One out. Runner on first and third. Batter flies out. Two out. Runner on third tags up and scores. Runner on first tries to retouch before throw from fielder reaches first baseman but does not get back in time and is out. Three outs. If, in umpire's judgment, the runner from third touched home before the ball was held at first base, the run counts.

A **FORFEITED GAME** is a game declared ended by the umpire-in-chief in favor of the offended team by the score of 6 to 0, for violation of the DYB official playing rules/regulations.

A **FOUL BALL** is a batted ball that settles on foul territory between home and first base, or between home and third base, or that bounds past first or third base on or over foul territory, or that first falls on foul territory beyond first or third base, or that while on or over foul territory, touches the person of an umpire or player, or any object foreign to the natural ground. **NOTE:** A foul fly shall be judged according to the relative position of the ball and the foul line, including the foul pole, and not as to whether the fielder is on foul or fair territory at the time that fielder touches the ball. **COMMENT:** A batted ball not touched by a fielder, which hits the pitcher's rubber and rebounds into foul territory, between home and first, or between home and third base is a foul ball.

**FOUL TERRITORY** is that part of the playing field outside the first and third base lines extended to the fence and perpendicularly upwards.

A **FOUL TIP** is a batted ball that goes sharp and direct from the bat to the catcher's hands and is legally caught. It is not a foul tip unless caught and any foul tip that is caught is a strike, and the ball is in play. It is not a catch if it is a rebound, unless the ball has first touched the catcher's glove or hand.

A **GROUND BALL** is a batted ball that rolls or bounces close to the ground.

The **HOME TEAM** is the team which takes the field first at the start of the game.

**ILLEGAL (or ILLEGALLY)** is contrary to these rules.

An **ILLEGAL PITCH** is (1) a pitch delivered to the batter when the pitcher does not have the pivot foot in contact with the pitcher's plate; (2) a quick return pitch; (2) when the pitcher delivers the pitch with a foreign substance applied to the ball. Rosin can be applied to the hand. Penalty for (1) is a no pitch. For (2) and (3) refer to Rule 8.02 (a).

An **ILLEGALLY BATTED BALL** is one hit by the batter with one or both feet on the ground entirely outside the batter's box. [Rule 6.06(a).]

An **INELIGIBLE PLAYER** is a player who is ineligible to be a member of a tournament team for a league because he/she does not live within the approved boundary of the league, a player who did not meet the participation requirements in his/her league, a player who violates Tournament Rule IV(C) or a player who is older than the maximum league age allowed for the respective age division of play. Example: A league age 12 player shall not play on a league age 10 and under division tournament team.

An **INFIELDER** is a fielder who occupies a position in the infield.

An **INFIELD FLY** is a fair fly ball (not including a line drive nor an attempted bunt) which can be caught by an infielder with ordinary effort, when first and second, or first, second and third bases are occupied, before two are out. The pitcher, catcher and any outfielder stationed in the infield on the play shall be considered infielders for the purpose of this rule. When it seems apparent that a batted ball will be an Infield Fly, the umpire shall immediately declare "Infield Fly" for the benefit of the runners. If the ball is near the baseline, the umpire shall declare "Infield Fly, if Fair." The ball is alive, and runners may advance at the risk of the ball being caught, or retouch and advance after the ball is touched, the same as on any fly ball. If the hit becomes a foul ball, it is treated the same as any foul. **COMMENT:** On the infield fly rule the umpire is to rule whether the ball

could ordinarily have been handled by an infielder—not by some arbitrary limitation such as the grass, or the base lines. The umpire must rule also that a ball is an infield fly, even if handled by an outfielder, if, in the umpire’s judgment, the ball could have been as easily handled by an infielder. The infield fly is in no sense to be considered an appeal play. The umpire’s judgment must govern, and the decision should be made immediately. When an infield fly rule is called, runners may advance at their own risk. If on an infield fly rule, the infielder intentionally drops a fair ball, the ball remains in play despite the provisions of Rule 6.05(l). The infield fly rule takes precedence. If interference is called during an Infield Fly, the ball remains alive until it is determined whether the ball is fair or foul. If fair, both the runner who interfered with the fielder and the batter are out. If foul, even if caught, the runner is out, and the batter returns to bat.

**NOTE:** If a declared Infield Fly is allowed to fall untouched to the ground and bounces foul and remains foul before passing first or third base, it is a foul ball. If a declared Infield Fly falls untouched to the ground, outside the baseline, and bounces fair before passing first or third base, it is an Infield Fly.

**IN FLIGHT** describes a batted, thrown, or pitched ball which has not yet touched the ground or some object other than a fielder.

**IN JEOPARDY** is a term indicating that the ball is in play and an offensive player may be put out.

An **INNING** is that portion of a game within which the teams alternate on offense and defense and in which there are three putouts for each team. Each team’s time at bat is a half-inning. An inning starts the moment the third out is made completing the preceding inning.

An **INTENTIONAL BASE ON BALLS** may be given by the defensive team by having its catcher request the umpire to award the batter first base. The request may be made before pitching to the batter or on any ball and strike count. The ball shall be declared dead before making the award.

### **INTERFERENCE**

(a) Offensive interference is an act by the team at bat which interferes with, obstructs, impedes, hinders or confuses any fielder attempting to make a play. If the umpire declares the batter, batter-runner or a runner out for interference, all other runners shall return to the last base that was, in the judgment of the umpire, legally touched at the time of the interference, unless otherwise provided by these rules. **COMMENT:** In the event the batter-runner has not reached first base, all runners shall return to the base last occupied at the time of the pitch; provided, however, if during an intervening play at the plate with less than two outs a runner scores, and then the batter-runner is called out for interference outside the three-foot lane, the runner is safe and the run shall count. Defensive interference is an act by a fielder which hinders or prevents a batter from hitting a pitch.

(b) Umpire’s interference occurs (1) when an umpire hinders, impedes or prevents a catcher’s throw attempting to prevent a stolen base, or (2) when a fair ball touches an umpire on fair territory before passing a fielder

(c) Spectator interference occurs when a spectator reaches out of the stands or goes on the playing field and touches a live ball.

(d) On any interference, the ball is dead.

**A LEAGUE** is a group of teams organized into a minimum of three teams and a maximum of 9 teams in 12U, 10U and 8U, and 11 teams in 6U age divisions, franchised within a common boundary, who play teams within their division in a pre-

arranged schedule under these rules for local league play to determine a league champion in each division.

**LEGAL (or LEGALLY)** is in accordance with these rules.

A **LINE DRIVE** is a batted ball that goes sharp and direct from the bat to a fielder without touching the ground.

A **LIVE BALL** is a ball which is in play.

A **LOCAL LEAGUE OPTION** gives a league the right to adopt any rule listed for “Local League Option”. If the league’s governing body fails to adopt the rule it does not apply. This option does not give a league the right to redesign the rule to its satisfaction but only the right to accept the option of using it or not.

**LOCAL LEAGUE TOURNAMENTS** are tournaments played at the local level between regular season teams. These local tournaments may be played using either regular season rules or tournament rules

The **MANAGER** is the one who supervises a team and whose name appears on the Team Player Registration Form.

(a) The manager shall always be responsible for the team’s conduct, observance of the official rules, and deference to the umpires.

(b) If a manager leaves the field, that manager shall designate the coach as a substitute and such substitute manager shall have the duties, rights, and responsibilities of the manager.

**OBSTRUCTION** is the act of a fielder, who, while not in possession of the ball, or not in the act of fielding the ball, impedes the progress of any runner. **COMMENT:** If a fielder is about to receive a thrown ball and if the ball is in flight directly toward and near enough to the fielder so he must occupy his position to receive the ball he may be considered “in the act of fielding a ball.” It is entirely up to the judgment of the umpire as to whether a fielder is in the act of fielding a ball. After a fielder has made an attempt to field a ball and missed, he can no longer be in the “act of fielding” the ball. For example: an infielder dives at a ground ball and the ball passes him and he continues to lie on the ground and delays the progress of the runner, he very likely has obstructed the runner.

**OFFENSE** is the team, or any player of the team, at bat. **OFFICIAL RULES.** The playing rules contained in this book.

**OFFICIAL SCORER.** See Rule 10.00.

An **OUT** is one of the three retirements of an offensive team during its time at bat.

An **OUTFIELDER** is a fielder who occupies a position in the outfield, which is the area of the playing field most distant from home base.

**OVERSLIDE (or OVERSLIDING)** is the act of an offensive player when the slide to a base, other than when advancing from home to first base, is with such momentum that the player loses contact with the base.

A **PENALTY** is the application of these rules following an illegal act.

The **PERSON** of a player or an umpire is any part of the body, clothing or equipment.

A **PITCH** is a ball delivered to the batter by the pitcher.

A **PITCHER** is the fielder designated to deliver the pitch to the batter.

The pitcher’s **PIVOT FOOT** is that foot which is in contact with the pitcher’s plate as the pitch is delivered.

“**PLAY**” the umpire’s order to start a game or resume action following a dead ball.

A **PLAY SITUATION** is anything covered under the DYB playing rules, regulations, and, where applicable, tournament rules.



A **QUICK RETURN** is a pitch made with obvious intent to catch a batter off balance. Refer to Rule 8.02 (a) (7). It is an illegal pitch.

**REGULATION GAME.** See Rules 4.10 and 4.11.

A **RETOUCH** is the act of a runner returning to a base as legally required.

A **RUN (or SCORE)** is the score made by an offensive player who advances from batter to runner and touches first, second, third, and home bases in that order.

A **RUN-DOWN** is the act of the defense to put out a runner between bases. A **RUNNER** is an offensive player who is advancing toward, or touching, or returning to any base.

A **SANCTIONED TOURNAMENT** is any tournament play approved by DYB, (including a two-out-of-three series) which allows each franchised league to enter two teams in "O"Zone or Majors, AAA, AA, and A divisions at the first level of tournament play to compete for the right to advance to subsequent levels of sanctioned play. **NOTE:** Any non-sanctioned tournaments supervised by DYB officials must be approved by the respective DYB state organizations.

"**SAFE**" is a declaration by the umpire that a runner is entitled to the base for which that runner was trying.

A **SERIES** is more than one game played between teams.

**SET POSITION** is one of the two legal pitching positions.

A **SQUEEZE PLAY** is a term to designate a play when a team, with a runner on third base, attempts to score that runner by means of a bunt.

A **STRIKE** is a legal pitch which meets any of these conditions (a) Is struck at by the batter and is missed; (b) Is not struck at, if any part of the ball passes through any part of the strike zone; (c) Is fouled by the batter when there are less than two strikes; (d) Is bunted foul (batter is out, and ball is dead, if batter bunts foul on third strike); (e) Touches the batter's person as the batter strikes at it (dead ball); (f) Touches the batter in flight in the strike zone; or (g) Becomes a foul tip.

The **STRIKE ZONE** is that area over home plate which is between the batter's armpits and the top of the knees when the batter assumes a natural stance. The umpire shall determine the strike zone according to the batter's natural stance as the batter is prepared to swing at a pitched ball.

A **SUSPENDED GAME** is a called game which is to be completed at a later date.

A **TAG** is the action of a fielder in touching a base with his body while holding the ball securely and firmly in his hand or glove; or touching a runner with the ball, or with his hand or glove holding the ball, while holding the ball securely and firmly in his hand

or glove. **COMMENT:** It is not a tag if simultaneously or immediately following his touching a base or touching a runner, the fielder drops the ball. In establishing the validity of the tag, the fielder shall hold the ball long enough to prove that he has complete control of the ball. If the fielder has made a tag and drops the ball while in the act of making a throw following the tag, the tag shall be adjudged to have been made.

A **THROW** is the act of propelling the ball with the hand and arm to a given objective and is to be distinguished, always, from the pitch.

A **TIE GAME** is a regulation game which is called when each team has the same number of runs.

"**TIME**" is the announcement by the umpire of a legal interruption of play, during which the ball is dead.

To **TOUCH** a player or umpire is to touch any part of the player or umpire's body, clothing or equipment.

A **TRIPLE PLAY** is a play by the defense in which three offensive players are put out as a result of continuous action, providing there is no error between putouts.

A **WILD PITCH** is one so high, or low, or wide of the plate that it cannot be handled with ordinary effort by the catcher.

**WIND-UP POSITION** is one of the two legal pitching positions.

### 3:00—GAME PRELIMINARIES

3.01—Before the game begins the umpires shall:

(a) Require strict observance of all rules governing team personnel, implements of play and equipment of players;

(b) No personal cell phones or other personal electronic communication equipment, excluding those carried by on-duty medical or security personnel or required to be “on call” by their profession, are allowed on the playing field or in the dugouts during all local league and tournament games. **EXCEPTION: Electronic devices may be used to keep pitch counts and lineups as long as they are not used to communicate outside the dugout via text, email or voice. PENALTY: Removal of the device from the dugout.**

(c) Be sure that all playing lines (heavy lines on Diagram No. 1 and No. 2) are marked with non-caustic lime, chalk, or other white material easily distinguishable from the ground or grass;

(d) Receive from the league a supply of baseballs which meet DYB specifications and standards. The umpire shall be the sole judge of the fitness of the balls to be used in the game;

(e) Be assured by the league that additional balls are immediately available for use if required;

(f) Have possession of at least two alternate balls and shall require replenishment of such supply of alternate balls as needed throughout the game. Such alternate balls shall be put in play when—

(1) A ball has been batted out of the playing field or into the spectator area;

(2) A ball has become discolored or unfit for further use;

(3) The pitcher requests such alternate ball.

3.02—No player shall intentionally discolor or damage the ball by rubbing it with soil, rosin, paraffin, licorice, sandpaper, emery-paper, or other foreign substance.

**PENALTY:** The umpire shall demand the ball and eject the offender from the game. In case the umpire cannot locate the offender, and if the pitcher delivers such discolored or damaged ball to the batter, the umpire shall warn the pitcher that repeated violations of this rule will cause the pitcher to be removed from the mound.

3.03(a)—A player or players may be substituted during a game at any time the ball is dead, except as covered herein. A substitute shall bat in the replaced player’s position in the team’s batting order but may be used in any fielding position.

Managers or coaches shall see that substitutions are properly called to the attention of the official scorekeeper. Any player, whether a starter or substitute, who has been removed from the game may reenter the game one time provided.

1. He occupies the same position in the batting order he originally occupied.

2. A pitcher does not return to the mound as a pitcher.

**NOTE:** A pitcher removed from the mound for a substitute pitcher in the defensive line-up may return to the game in another defensive position but may not return to the mound as a pitcher.

**NOTE 1:** It will be held that an inning starts the moment the third out is made, completing the previous inning.

**NOTE 2:** “Exception”: In the event a manager has used all his eligible players and a player is injured, becomes ill and cannot continue, is ejected or removed from the game by an umpire or official, or is not present when a suspended game is resumed, the game shall not be forfeited. The opposing manager shall select a player from the bench who can play the position of the injured or ill player, but who has already been in the game, and this player shall replace the injured or ill player.

3.03(b)—Illegal substitutions must be noticed by the opposing manager and called to the attention of an umpire immediately upon the illegal substitute entering the game and before another pitch is thrown or before another play. If no complaint of an illegal substitution is made before the first pitch or play, the substitution then becomes legal.

**PENALTY FOR VIOLATION:** (when noticed and protested as outlined above): Immediate removal of the illegal substitute from the game.

**NOTE:** For the purpose of this rule, a player enters the game when:

- (a) a batter steps into the batter’s box;
- (b) a fielder takes a fielding position;
- (c) a runner takes a position on the base path as a runner.

3.03(c)—If an illegal pitcher enters the game, or becomes illegal after entering the game, this is a continuing violation and may be protested at any time during its continuation prior to the completion of the game.

**PENALTY FOR VIOLATION:** The illegal pitcher shall be removed from the mound and the offended team shall have the choice of replaying the game from the point the illegal pitcher entered the game to pitch or continue from the point when the violation is discovered. Umpires will enforce a valid protest prior to the completion of the game. League or tournament officials will enforce the penalty after the completion of the game only if the umpire fails to enforce the penalty when properly protested during the game. If otherwise eligible, a pitcher who is removed from the mound may stay in the game in another defensive position.

**NOTE 1:** For the purpose of this rule, a player enters the game as a pitcher when He has delivered the first pitch.

**NOTE 2:** Pitches thrown by an illegal pitcher shall count as pitches thrown toward the pitch count thresholds and daily pitch count limits.

**EXAMPLE:** John Martin pitches 31 or more pitches on Tuesday, then starts as pitcher on Wednesday during his rest period. He is an illegal pitcher for the entire game on Wednesday, however if he is not noticed and protested before the game ends, it is a legal game and no protest can be made of that game based on John Martin being an illegal pitcher. At any time, during the Wednesday game, upon proper protest, John Martin may be removed from the mound. If John Martin pitches on Thursday, he is continuing the violation and again subject to removal upon proper protest (any innings pitched on Wednesday or Thursday still count toward the daily pitch count limit).

**3.03(d)—OFFENSIVE PARTICIPATION REQUIREMENT.** For local league play, each league must comply with the participation requirements in one of three local league options described below in 3.03(d)(1), 3.03(d)(2) or 3.03(d)(3).

**NOTE: Players who are injured may not participate in any game if they are unable to meet both the offensive and defensive participation requirements.**

**3.03(d)(1)–Local League Option #1** - All players on every team must play at least three consecutive outs on defense and complete one time at bat in each game played by his/her team. **PENALTY: If the winning team violates this rule, it shall forfeit the game provided that the opposing manager files a protest within the fifteen-minute time limit allowed for such protest (Refer to Rule 4.19, Paragraph (E), Note 2). (In addition, the umpire-in-chief shall declare a forfeit for any team, which attempts to intentionally allow the opposing team to score in order to extend the game so that it may comply with the player participation requirement.) If both teams violate the rule, both teams shall forfeit the game.**

**EXAMPLE:** Team A, at the start of the game, has only 10 players and Team B has 12 players. **RULING:** Team A must play 10 players and Team B must play 12 players. (A complete time at bat begins when a player takes a position in the batter's box as a batter with a count of no balls and no strikes and ends when that player reaches base safely or is declared out.)

**SPECIAL NOTE:** Local leagues shall have the authority to adopt local rules requiring more than one defensive inning of participation and one complete time at bat.

**3.03(d)(2)–Local League Option #2** - Managers shall be required to list all players in the batting order for each game.

(i) The batting order shall remain the same throughout the game. **EXCEPTION:** If removed from offense while at bat for an injury, medical reason, or ejection the next batter will begin his at bat and will assume the count of the removed player. If removed from offense while on base for an injury, medical reason, or ejection, the last preceding player not on base will run for removed player.

**EXAMPLE:** If the Number 5 batter is replaced on base under this rule, the Number 4 batter would replace the removed player. If the Number 4 batter is already on base, then continue to Number 3 or Number 2 batter and so on until the selection of the replacement involves someone who is not currently on base.

This rule is intended to prevent a player from coming to bat for a player who is on base while running for another player and to eliminate manipulation of runners.

(ii) If a player listed in any batting position in a continuous batting lineup leaves the game because of an injury, illness or disqualification, this position in the batting lineup will be skipped for the remainder of the game without penalty. No player will be called "out" who is skipped by rule in the batting lineup.

(iii) All players shall be required to enter the game on defense and each player shall complete a minimum of three defensive outs during the game.

(iv) If a player arrives after the continuous batting order has been submitted to the scorer, the player must be added to the end of the continuous batting order.

Players who arrive late shall be substituted for the next batter in the lineup when they enter a game late and have them bat immediately only if the late player cannot mathematically have a plate appearance. If this is the case, then the substituted player will skip his at-bat once and the substitute player will go to the last position in the batting order for the remainder of the game. If a player arrives after the fifth inning has begun, he SHALL NOT participate in the game.

**NOTE 1:** For the purposes of satisfying Rules 3.03(d)(1) and 3.03(d)(2), a substitute is considered in the game when his name has been added to the batting order by the official scorer and until he is replaced by the official scorer. His name must appear in the batting order for three defensive outs and he must complete one time at bat, except for the extra players as referenced in ruling under 3.03 above.

**NOTE 2:** This requirement shall apply to both teams even if the last half of the sixth inning is not required. The only exceptions shall be when the game is considered a regulation game but is not completed in six innings (five and one-half innings with the Home Team leading) because of the 10 or 15 run rule or is shortened because of a game time limit or curfew, or acts of God, or when a team concedes before all available players have participated.

**NOTE 3:** League officials, other than managers or coaches, shall be empowered to make exceptions to 3.03(d)(1) and 3.03(d)(2) in the event of injury or sickness of a player who is unable to complete an inning or a time at bat.

### **3.03(d)(3)–Local League Option #3**

(i) At the start of the game, all available players on each team roster will be listed in the starting offensive batting lineup and bat in this order until all have completed one turn at bat. After all players in the initial batting lineup have batted once, the official offensive lineup will revert to the first nine players listed in the original batting lineup for the remainder of the game. The players not listed in first nine batting positions will become official substitutes and will be eligible to return to the official batting lineup in one of the first nine offensive batting lineup positions at any time.

(ii) If a player arrives after the batting order has been submitted but before the initial time through the batting order has been completed, the player must be added to the end of the batting order. If the batting order has reverted to the original nine-man order, a player arriving before the fourth inning has been completed must fulfill his batting requirement and must play defense. If a player arrives after the fifth inning has begun, he SHALL NOT participate in the game.

(iii) If a player not listed in the first nine batting positions leaves the game because of an injury, illness or disqualification, before he takes his initial turn at bat, this position in the batting lineup will be skipped and the next batter in order takes his place. If this offensive position is one of the top nine, the removed player's position will be filled by one of the official substitutes.

(iv) A player removed because of injury or illness may return to the game.

(v) If a manager has used all his eligible players and a player is injured or becomes ill and cannot continue, the game shall not be forfeited. The opposing manager shall select a player from the bench who has already been in the game to replace the injured or ill player in the injured or ill player's batting position.

### **3.03(e) FREE SUBSTITUTION ON DEFENSE**

(1) Except for the pitcher, any player may enter the game in any defensive position as many times as deemed necessary by the team manager.

(2) Players shall enter the game on defense only at the beginning of each team's defensive inning unless the defensive player enters the game to replace an injured, ill or ejected player or enters the game during a pitching change. Entering the game on defense does not count as entering/ reentering on offense for the purpose of Rule 3.03(a).

3.04–After all players have batted, a player whose name is not listed in the top nine batting positions on the team's batting order may be used as a courtesy runner for a pitcher or catcher. "Courtesy runners" are not permitted for other playing positions. The same player cannot be used to run for both the pitcher and catcher positions. **NOTE: When using the "Continuous Batting Order", the player who made the last out (except the pitcher and catcher) may be used as a "Courtesy Runner" for the pitcher or catcher.**

3.05–(a) The pitcher named in the batting order handed to the official scorer, as provided in Rules 4.01(a) and 4.01(b) shall pitch to the first batter or any substitute batter until such batter or any substitute batter is put out or reaches first base, unless the pitcher sustains injury or illness which, in the judgment of the umpire-in-chief, incapacitates the pitcher from pitching.

(b) If the pitcher is replaced, the substitute pitcher shall pitch to the batter then at bat, or any substitute batter, until such batter is put out or reaches first base, or until the offensive team is put out, unless the substitute pitcher sustains injury or illness, which in the umpire-in-chief’s judgment, incapacitates the pitcher from pitching further.

3.06 –The manager shall immediately notify the umpire-in-chief of any substitution and shall state to the scorer the substitute’s place in the batting order.

3.07 –The scorer, after having been notified, shall immediately announce, or cause to be announced, each substitution.

3.08 –(a) If no announcement of a substitution is made, the substitute shall be considered to have entered the game when:

(1) If a pitcher, the substitute takes position on the pitcher’s plate and commences making warm up pitches during an inning or commences making preliminary pitches at the beginning of his/her team’s defensive half of the inning;

(2) If a batter, the substitute takes position in the batter’s box;

(3) If a fielder, the substitute reaches the position usually occupied by the fielder being replaced and play commences;

(4) If a runner, the substitute takes the place of the runner being replaced;

(b) Any play made by, or on, an unannounced substitute shall be legal.

3.09–Players, managers, and coaches of the participating teams shall not address, come in contact with spectators, nor sit in the stands during a game in which they are engaged.

3.10–(a) The local league officials shall determine the fitness of the playing field before the game starts. **EXCEPTION:** During tournament play, the tournament director shall determine the fitness of the playing field.

(b) The umpire-in-chief shall be the sole judge as to whether and when play shall be suspended during a game because of unsuitable weather conditions or the unfit condition of the playing field; as to whether and when play shall be resumed after such suspension; and as to whether and when a game shall be terminated after such suspension. Said umpire shall not call the game until at least thirty minutes after play has been suspended. The umpire may continue suspension if there is any chance to resume play.

3.11–Whenever a game is suspended because of the unfitness of the playing field, the local league president, or his designated representative, and the tournament director, during tournament play, shall have control of grounds-keepers for the purpose of making the playing field fit for play.

3.12–When the umpire suspends play, “Time” shall be called. At the umpire’s call of “Play” the suspension is lifted and play resumes. Between the call of “Time” and the call of “Play” the ball is dead.

3.13–The local league will establish ground rules to be followed by all teams in the league for each playing field. The tournament director will establish ground rules to be followed by all teams in tournament play.

3.14–Members of the offensive team shall carry all gloves and other equipment off

the field and to the dugout while their team is at bat. No equipment shall be left lying on the field, either in fair or foul territory.

3.15 –No person shall be allowed on the playing field during a game except uniformed players, managers, coaches, umpires, and news photographers authorized by the league. In case of unintentional interference with play by any person herein authorized to be on the playing field (except members of the offensive team participating in the game, or a coach in the coach’s box, or an umpire) the ball is alive and in play. If the interference is intentional, the ball is dead at the moment of the interference and the umpire shall impose such penalties as in his opinion will nullify the act of interference. See Rule 7.11 for individuals excepted above, and Rule 7.08(b).

3.16–When there is spectator interference with any thrown or batted ball, the ball shall be dead at the moment of interference and the umpire shall impose such penalties as in the umpire’s opinion will nullify the act of interference.

**APPROVED RULING:** If spectator interference clearly prevents a fielder from catching a fly ball, the umpire shall declare the batter out.

3.17 –Players and substitutes shall sit on their team’s bench or in the dugout unless participating in the game or preparing to enter the game. No one except eligible players in uniform and the manager and coaches shall occupy the bench or dugout. When batters or base runners are retired, they must return to the bench or dugout at once.

3.18 –The local league shall provide proper protection sufficient to preserve order and to prevent spectators from entering the field.

#### **4.00 —STARTING AND ENDING THE GAME**

4.01 –Prior to the established time to begin the game, the managers of the opposing teams shall follow the following routine in sequence:

(a) The home team manager and the visiting manager shall give their team batting orders in duplicate to the official scorer;

(b) The official scorer shall make certain that the original and duplicate copies are the same, then provide a copy of each batting order to the opposing manager. The original copy retained by the official scorer shall be the official batting order.

(c) As soon as the umpire-in-chief enters the playing field, the umpires are in charge of the playing field and from that moment have sole authority to determine when a game shall be called, halted, or resumed on account of weather or the conditions of the playing field.

4.02 –The players of the home team shall take their defensive positions, the first batter of the visiting team shall take position in the batter’s box, the umpire shall call “Play,” and the game shall start.

4.03 –When the ball is put in play at the start of, or during a game, all fielders other than the catcher shall be in fair territory.

(a) The catcher shall be stationed directly back of the plate in the catcher’s box. PENALTY: “O”Zone Penalty: Balk (No Pitch).

(b) The pitcher, while in the act of delivering the ball to the batter, shall take the legal position.

(c) Except the pitcher and the catcher, any fielder may be stationed anywhere in fair territory.

(d) Except the batter, or runner attempting to score, no offensive player shall cross the catcher’s lines when the ball is in play.

4.04 –The batting order shall be followed throughout the game unless a player is substituted for another. Substitutes must take the place of the replaced player’s position in the batting order.

4.05 –(a) The offensive team shall station two base coaches on the field during its time at bat, one near first base and one near third base. Base coaches shall remain within the base coaches’ boxes at all times and talk to members of their own team only. An offending base coach shall be removed from base coach’s box.

(b) Base coaches on the baselines shall be:

(1) Two (2) eligible players in uniform wearing protective helmets, or

(2) One (1) eligible player in uniform wearing a protective helmet and one (1) adult team manager or team coach presenting a neat appearance including shirt, pants and shoes. (No metal or removable cleats are allowed), or

(3) Two (2) adult team manager or coaches presenting a neat appearance, including shirt, pants and shoes. (No metal or removable cleats are allowed.)

NOTE 1: If (2) above is chosen, the adult team manager or team coach shall choose either the first or third base coaches’ box at the beginning of the game and shall not change baselines during the game. Any conduct by any base coach considered in the umpire’s judgment to be unsportsmanlike or a deliberate attempt to delay the game shall result in: (a) if an adult, the immediate removal of the offender from the game and the playing field and its confines; (b) if a player, the immediate removal of the offender from the coaching box(es) for the remainder of the game. NO WARNING SHALL BE NECESSARY.

NOTE 2: At least one adult coach must be in the dugout at all times possibly limiting the number of adult coaches allowed to coach on the baselines. In this event, at least one, or possibly two, eligible players in uniform, wearing a protective helmet, must be used as a coach on the baseline. Both base coaching boxes must be filled at all times when a team is on offense.

(c) A player who is removed from the game by his manager shall be eligible to be used as a coach.

4.06 –(a) No manager, coach or player, shall at any time, whether from the bench or the playing field or elsewhere:

(1) Incite, or try to incite, by word or sign, a demonstration by spectators;

(2) Use language which will in any manner refer to or reflect upon opposing players, manager, coach, an umpire, or spectators.

(3) (“O”Zone Play Only) Call “Time,” or employ any other word or phrase or commit any act while the ball is alive and in play for the obvious purpose of trying to make the pitcher commit a balk.

(4) Make intentional contact with the umpire in any manner.

(b) No fielder shall take a position in the batter’s line of vision, and with deliberate unsportsmanlike intent, act in a manner to distract the batter.

**PENALTY:** The offender shall be ejected from the game.

4.07 –When a manager, coach or player is ejected from a game, they shall leave the field immediately and take no further part in the game. Managers and coaches may not sit in the stands or remain in the dugout. Managers, coaches and players may not be recalled. Players only may remain in the dugout.

4.08 –When the occupants of a player’s bench show violent disapproval of an umpire’s decision, the umpire shall first give warning that such disapproval shall cease. If such action continues: **PENALTY:** The umpire shall order the offender out of the game and away from the spectator’s area.



#### 4.09 –HOW A TEAMS SCORES

(a) One run shall be scored each time a runner legally advances to and touches first, second, third and home base before three players are put out to end the inning.

**EXCEPTION:** A run is not scored if the runner advances to home base during a play in which the third out is made: (1) by the batter-runner before touching first base; (2) by any runner being forced out; or (3) by a preceding runner who is declared out because that runner failed to touch one of the bases (appeal play).

(b) When the winning run is scored in the last half inning of a regulation game, or in the last half of an extra inning, as the result of a base on balls, hit batter, or any other play with the bases full which forces the runner on third to advance, the umpire shall not declare the game ended until the runner forced to advance from third has touched home base and the batter-runner has touched first base.

4.10(a)–It shall be a regulation game when:

(1) Both teams have completed six innings, and the visiting team has scored more runs than the home team.

(2) The home team has scored more runs after five innings than the visiting team has scored in six innings.

(3) The home team scores the winning run in the last half of the sixth inning before the third out.

(4) After the end of six innings with the score tied, play is continued until one team has scored more runs than the other in an equal number of innings. If the home team scores the winning run before the third out in any extra inning, the game shall be ended.

(5) **EXCEPTION:** When a team is ten (10) runs ahead after three (3) complete innings of play and the game is called because of darkness, rain or any other cause, it shall be a legal game and the team ahead shall be the winner.

(6) Games shortened by reason of curfew, rain, or other acts of God shall be regulation games provided both teams have batted four times, or in the case of the home team when it is leading, three times.

(7) [Local League Option] Games shortened by reason of curfew, rain, or other acts of God before they have become regulation games shall be resumed from the point of termination.

(8) A local league may use a time limit for regular season games to determine a regulation game so long as both teams have had an equal number of times at bat. **EXCEPTION:** In the event a game is called because of a time limit, with the home team leading, it will not be necessary for the last half of the inning in progress to be played when the time limit expires. **NOTE:** No new inning may begin once the time limit has been reached. An inning ends the moment the third out is made. Therefore, the next inning begins at the same time. If the time limit expires with an inning in progress when time expires, the inning should be completed or the half inning if the home team is ahead.

(9) **15 RUN RULE** - A game shall be considered a regulation game when a team is ahead by fifteen (15) runs after both teams have batted three times, or in the case of the home team when it is leading, two times and all batters have batted at least once. Pitchers shall only be charged for innings actually pitched.

**NOTE: THE VISITING TEAM WILL BE DECLARED THE WINNER OF A GAME UNDER THE 15 RUN RULE PROVISION ONLY IF THE HOME TEAM HAS HAD AN EQUAL NUMBER OF TIMES AT BAT.**

(10) **10 RUN RULE** - A game shall be considered a regulation game when a team is ahead by ten (10) runs after both teams have batted four times, or in the case of the home team when it is leading, three times and all batters have batted at least once.

**NOTE: THE VISITING TEAM WILL BE DECLARED THE WINNER OF A GAME UNDER THE TEN-RUN RULE PROVISION ONLY IF THE HOME TEAM HAS HAD AN EQUAL NUMBER OF TIMES AT BAT.**

(11) **AA Local League Option** - A league may adopt a rule to allow a maximum of seven (7) runs per inning in local league AA regular season play. A team may score more than seven (7) runs on a ground rule double or an over the fence home run.

4.10(b)–It is a regulation tie game when:

(1) The score is even after four or more complete innings.

(2) After three and one-half or more innings, the home team is at bat and has scored enough runs to make the score even and the game is called.

(3) Tie games shall be replayed, or played from the exact point of termination at the option of the local league. Pitchers shall be subject to regular eligibility rules, and under no condition shall they pitch in more innings than allowed by Rule 8.07. **NOTE:** This rule does not give a pitcher extra eligibility of innings because he did not use his eligible innings in the week in which the original tie game was stopped.

(4) Any game which does not meet any of the conditions noted above shall be declared no contest and shall be replayed from the beginning. See 4.10(c) exception.

4.10(c)–League championships decided by one game shall be played to a conclusion, regardless of the score or inning, unless the game is shortened because one team is ahead by 15 runs or 10 runs pursuant to Rules 4.10(a)(9) or 4.10(a)(10) or the team behind wishes to concede. If the game is suspended for any other reason, it shall be completed at the earliest possible date and shall be played from the point of termination.

4.11–The score of a regulation game is the total number of runs scored by each team at the moment the game ends.

(a) The game ends when the visiting team completes its half of the sixth inning if the home team is ahead.

(b) The game ends when the sixth inning is completed, if the visiting team is ahead.

(c) If the home team scores the winning run in its half of the sixth inning (or its half of an extra inning after a tie), the game ends immediately when the winning run is scored. **EXCEPTION:** If the last batter in a game, hits a home run out of the playing field, the batter-runners on base are permitted to score and the game ends when the batter-runner touches home plate.

**APPROVED RULING:** The batter hits a home run out of the playing field to win the game in the last half of the sixth or an extra inning but is called out for passing a preceding runner. The game ends immediately when the winning run is scored.

(d) A called game ends at the moment the umpire terminates play.

**EXCEPTION:** If the game is called during an incomplete inning, the local league shall determine whether to complete the game at a later time; or end the game at the end of the last previous completed inning in each of the following situations:

(1) The visiting team scores one or more runs to tie the score in the incomplete inning, and the home team does not score in the incomplete inning.

(2) The visiting team scores one or more runs to take the lead in the incomplete inning, and the home team does not tie the score or retake the lead in the incomplete inning.

4.14—The umpire-in-chief shall order the playing field lights turned on whenever in such umpire’s opinion darkness makes further play in daylight hazardous.

4.15— A game may be forfeited to the opposing team by the umpire-in-chief of the game in progress when a team—

- (a) Being upon the field, refuses to start play within 10 minutes after the appointed hour for beginning the game, unless such delay, in the umpire’s judgment, is unavoidable;
- (b) Refuses to continue play unless game was terminated by the umpire;
- (c) Fails to resume play, after game was halted by the umpire, within one minute after the umpire has called “Play”;
- (d) Fails to obey the umpire’s order to remove a player from the game;
- (e) After warning by the umpire, willfully and persistently violates the rules;
- (f) Employs tactics designed to delay, shorten or extend the game.

**NOTE:** Any team which attempts to intentionally allow the opposing team to score in order to extend the game so that it may comply with the player participation requirement in 3.03(d)(1) or (d)(2) (or Tournament Rule IX(A)) shall forfeit the game.

4.16—Reserved

4.17—(a) A team failing to field at least nine (9) players within fifteen (15) minutes after the scheduled game time shall forfeit the game. (SEE EXCEPTION).

(b) A game in progress shall be forfeited to the opposing team when either team is unable or refuses to place nine players on the field. (SEE EXCEPTION)

**EXCEPTION #1:** (Local League Option) – A league may adopt a local league provision to permit a team to start or end a game with a minimum of eight players.

**EXCEPTION #2:** (Local League Option) – A league may adopt a local league provision to permit a team to use players from another team’s roster in the league to prevent a forfeit. However, the league may only allow the number of players added for any one game to be the number necessary to provide a team with a minimum of nine players to start a game. **Any player added to a regular season roster to pre-vent the forfeit of a game shall not be eligible to pitch during the game. No team may bench a player on the team’s regular roster while a player added to the roster for one game is in the game, unless the rostered player is sick or injured and cannot continue in the game.**

(c) When a suspended game is played on a future day, players who were present during the start of the game but are absent when the suspended game is rescheduled shall be skipped where the players are in a continuous batting order without penalty.

4.18—Forfeited games shall be so recorded in the scorebook and the book signed by the umpire-in-chief. A written report stating the reason for the forfeiture shall be sent to the league president within 24 hours, but failure of the umpire to file this report shall not affect the forfeiture.

#### **4.19—PROTESTS-Local League Play**

- (a) A protest which involves an umpire’s judgment shall not be accepted.
- (b) Only the team manager or the acting team manager shall be entitled to file a protest to these rules and regulations which apply to the 9-10 and 11-12 age divisions.
- (c) The only legal protest shall be one which involves a violation of playing rules or the use of an ineligible player. Playing ineligible players may result in forfeiture of games in which players participated if protested by any of the league managers. The local league will decide if the game shall be forfeited for playing ineligible players.

Note: Illegal pitchers are not ineligible players as defined in Note 1 below. See rule 3.03(c) for the penalty for illegal pitchers.

(d) The protesting manager on a play situation shall notify the umpire he is protesting before another pitch is thrown. The umpire shall announce that the game is being played under protest, but failure of the umpire to make this announcement shall not affect the validity of the protest. The protest shall be considered only if it is placed in writing by team manager or acting team manager and submitted to the local league president within forty-eight (48) hours from the completion of the game.

(e) A protest on the grounds of ineligibility of a player shall be filed with the local league president within forty-eight (48) hours after the completion of the game. The decision as to whether the game, or games, shall be forfeited or replayed, in the event the protest is upheld, shall be left to the discretion of the local governing body.

**NOTE 1:** Only the game or games protested shall be considered, and all protests of this nature shall be made within forty-eight (48) hours. An illegal substitution is one in violation of playing rules and includes the improper use of a pitcher. Paragraph (d) applies to illegal substitutions and paragraph (e) to ineligibility of a player.

For the purpose of this rule, an ineligible player shall be a player who is not eligible to participate in the league because of age, boundary requirements or other reasons and is not to be confused with illegal substitutions.

**NOTE 2:** AFTER THE COMPLETION OF A GAME, THERE SHALL BE NO PROTEST REGARDLESS OF THE CIRCUMSTANCES INVOLVED WITH THE EXCEPTION OF A PROTEST ON ELIGIBILITY OR FAILURE TO COMPLY WITH THE ONE INNING PARTICIPATION REQUIREMENT. A game shall not be considered as complete until opposing managers have an opportunity to make a protest on a game-ending play or failure to comply with the one-inning participation requirement. Fifteen minutes shall be considered sufficient time for the fulfillment of this rule.

(f) Any protest in local league play shall be ruled upon by the governing body at the local league level and there shall be no appeal of the league's final decision with the following exception:

(1) If the manager of the team ruled against has evidence that the protest decision is in conflict with DYB official rules and regulations, he may file a written appeal of the protest decision to the district director. Such appeal must be filed within forty-eight (48) hours from the time that a final written decision is issued by the local league's governing body.

(a) A valid appeal of a protest decision by a local league's governing body must include: i) A check in the amount of \$10.00, payable to the district director. If the original protest decision is upheld, the funds will be deposited in the district operating fund. If the appeal is reversed, the check will be returned to the appealing manager; ii) a copy of the league's written decision from the local protest committee chairman or league president which details the protest situation and the league's reasons for its decision; and iii) a complete explanation from the appealing manager as to what specific DYB rule or regulation was violated and/or misinterpreted.

(b) The district director, with the approval of the state director, shall have the authority to overrule any local league protest decision if it is in conflict with DYB rules and regulations.

(c) Only the state director shall have the authority to contact the Commissioner for an official interpretation if the state director deems it necessary or advisable to do so.

## 5.00 —PUTTING THE BALL IN PLAY—LIVE BALL

5.01 –At the time set for beginning the game the umpire-in-chief shall order the home team to take its defensive positions and the first batter of the visiting team to take position in the batter’s box. As soon as all players are in position the umpire-in-chief shall call “Play”.

5.02 –After the umpire calls “Play” the ball is alive and in play and remains alive and in play until, for legal cause, or at the umpire’s call of “Time” suspending play, the ball becomes dead. While the ball is dead, no player may be put out, no bases may be run and no runs may be scored, except that runners may advance one or more bases as the result of acts which occurred while the ball was alive (such as, but not limited to an overthrow, interference, or a home run or other fair hit out of the playing field).

5.03 –The pitcher shall deliver the pitch to the batter who may elect to strike the ball, or who may not offer at it, as such batter chooses.

5.04 –The offensive team’s objective is to have its batter become a runner, and its runners advance.

5.05 –The defensive team’s objective is to prevent offensive players from becoming runners, and to prevent their advance around the bases.

5.06 –When a batter becomes a runner and touches all bases legally, one run shall be scored for the offensive team.

5.07 –When three offensive players are legally put out, that team takes the field and the opposing team becomes the offensive team.

5.08 –If a thrown ball accidentally touches a base coach, or a pitched or thrown ball touches an umpire, the ball is alive and in play. However, if the coach interferes with a thrown ball, the runner is out.

5.09 –The ball becomes dead and runners may advance one base, or return to their bases as indicated below, without liability to be put out, when—

(a) A pitched ball touches a batter, or the batter’s clothing, while in a legal batting position; runners, if forced, advance (see 6.08);

(b) The plate umpire interferes with the catcher’s throw attempting to prevent a stolen base; runners return. If catcher’s throw gets the runner out, the out stands. No umpire interference;

(c) A ball is illegally batted either fair or foul; runners return;

(d) A foul ball not caught; runners return. The umpire shall not put the ball in play until all runners have retouched their bases;

(e) A fair ball touches a runner or an umpire on fair territory before it touches an infielder including the pitcher or touches an umpire before it has passed an infielder other than the pitcher. Runner hit by fair batted ball is out. The ball is dead, and no runners advance.

**NOTE:** If a fair ball goes through, or by an infielder and touches a runner immediately back of said infielder or touches a runner after being deflected by an infielder, the ball is in play and the umpire shall not declare the runner out. The umpire must decide that the ball passed through, or by, the infielder and that no other infielder had the chance to make a play on the ball; runners advance, if forced.

(f) A pitched ball lodges in the umpire’s or catcher’s mask or paraphernalia and remains out of play; runners advance one base.

5.10—The ball becomes dead when an umpire calls “Time.” The umpire-in chief shall call “Time”.

(a) When in said umpire’s judgment, weather, darkness or similar conditions make immediate further play impossible;

(b) When light failure makes it difficult for the umpires to follow the play;

(c) When an accident incapacitates a player or an umpire;

(1) If an accident to a runner prevents said runner from proceeding to an entitled base, as on a home run hit out of the playing field or an award of one or more bases, a substitute runner, shall be permitted to complete the play.

(d) When a manager requests “Time” for a substitution, or for a conference with one of the players;

(e) When the umpire wishes to examine the ball, to consult with either manager, or for any similar cause;

(f) When a fielder, after catching a fly ball, falls into a bench or stand, or falls across ropes into a crowd when spectators are on the field. Runners advance one base, ball is dead; NOTE: If a fielder, after making a catch, steps into a bench but does not fall, the ball is in play and runners may advance at their own peril.

(g) When an umpire orders a player, or any other person removed from the playing field;

(h) Except in the cases stated in paragraphs (b) and (c) (1) of this rule, no umpire shall call “Time” while a play is in progress.

5.11—After the ball is dead, play shall be resumed when the pitcher takes position on the pitcher’s plate with a new ball or the same ball in said pitcher’s possession and the plate umpire calls “Play.” The plate umpire shall call “Play” as soon as the pitcher takes position on the plate with possession of the ball.

5.12—A manager shall be entitled to request time, on defense, to talk to his players twice during the same inning while the same pitcher is on the mound without penalty. On the third request for time with the same pitcher on the mound, the manager shall be required to remove the pitcher from the mound but not the game.

**EXAMPLE:** With Bill Smith pitching, the manager requests and is granted his third time out of the inning. Bill Smith consequently is removed from the mound and is replaced with Sam Scott. Bill Smith is eligible to go to another position or he can come out of the game. The manager subsequently is granted a fourth time out in the same inning. There is no violation this time, and Sam Scott may continue to pitch until the third time out is granted with him on the mound.

5.13—One time-out shall be allowed on offense to talk to a batter during the same time at-bat. Requesting a second time-out to talk to the batter during the same at-bat shall result in the coach being removed from the coach’s box and placed in the dugout for the remainder of the game.

NOTE: A time-out because of injury or sickness or for the purpose of discussing a play situation with an umpire shall not be considered a charged time out for the purpose of this rule. Also, managers are cautioned that an umpire is the only one who can call time; managers may only request that time be called by the umpire.

## 6.00 —THE BATTER

6.01—(a) Each player of the offensive team shall bat in the order that their name appears in the team’s batting order.

(b) The first batter in each inning after the first inning shall be the player whose name follows the last player who completed a time at bat in the preceding inning.

**NOTE:** In the event that while a batter is in the batter's box, the third out of an inning is made on a base runner, the batter then at bat shall be the first batter of the next inning and the count of balls and strikes shall start over.

6.02 –(a) The batter shall take position in the batter's box promptly when it is said batter's time at bat.

(b) The batter shall not leave that position in the batter's box after the pitcher comes to Set Position or starts a windup. **PENALTY:** If the pitcher pitches, the umpire shall call "Ball" or "Strike" as the case may be.

(c) If the batter refuses to take position in the batter's box during a time at bat, the umpire shall order the pitcher to pitch, and shall call "Strike" on each such pitch. The batter may take a proper position after any such pitch, and the regular ball and strike count shall continue, but if the batter does not take proper position before three strikes are called, that batter shall be declared out.

6.03 –The batter's legal position shall be both feet within the batter's box.

**APPROVED RULING:** The lines defining the box are within the batter's box.

6.04 –A batter has legally completed a time at bat when put out or becomes a runner.

6.05 –A batter is out when–

(a) A fair or foul fly ball (other than a foul tip) is legally caught by a fielder;

(b) A third strike is legally caught by the catcher;

(c) (1) A third strike is not caught by the catcher except for a foul tip. The batter shall be out, and the ball shall remain in play, and base runners shall advance at their own risk.

(2) **"O"Zone Play** - A third strike is not caught by the catcher, when first base is occupied before two are out;

(d) Bunting foul on a third strike;

(e) An Infield Fly is declared;

(f) That batter attempts to hit a third strike and is touched by the ball;

(g) A fair ball touches said batter before touching a fielder;

(h) After hitting or bunting a fair ball, while holding the bat, the bat hits the ball a second time in fair territory. The ball is dead, and no runner may advance. If the batter-runner drops the bat and the ball rolls against the bat in fair territory and, in the umpire's judgment there was no intention to interfere with the course of the ball, the ball is alive and in play;

(i) After hitting or bunting a foul ball, that runner intentionally deflects the course of the ball in any manner while running to first base. The ball is dead, and no runners may advance;

(j) (1) After hitting a fair ball, the batter-runner or first base is tagged before said batter-runner touches first base;

(2) **"O"Zone** - After a third strike the batter-runner or first base is tagged before said batter-runner touches first base;

(k) In running the last half of the distance from home base to first base, while the ball is being fielded to first base, the batter-runner runs outside (to the right of) the three-foot line, or inside (to the left of) the foul line, and in the umpire's judgment in so doing interferes with the fielder taking the throw at first base; except that the batter-runner may run outside (to the right of) the three-foot line or inside (to the left of) the foul line to avoid a fielder attempting to field a batted ball;

(l) An infielder intentionally drops a fair fly ball or line drive, with first, first and second, first and third, or first, second and third bases occupied before two are out.

The ball is dead, and runner or runners shall return to their original base or bases; **APPROVED RULING:** In this situation, the batter is not out if the infielder permits the ball to drop untouched to the ground, except when the Infield Fly rule applies.

(m) A preceding runner shall, in the umpire's judgment, intentionally interfere with a fielder who is attempting to catch a thrown ball or to throw a ball in an attempt to complete a play.

6.06 –**A batter is out for illegal action when–**

(a) Hitting an illegally batted ball (See Rule 2:00–Definitions);

(b) Stepping from one batter's box to the other while the pitcher is in position ready to pitch;

(c) Interfering with the catcher's fielding or throwing by stepping out of the batter's box or making any other movement that hinders the catcher's play at home base.

**EXCEPTION:** Batter is not out if any runner attempting to advance is put out, or if runner trying to score is called out for batter's interference.

(d) **“O”Zone Play** - With a runner on 3rd base attempting to steal home with the pitch, THE BATTER MUST BUNT OR TAKE THE PITCH. If the batter swings, the ball will be dead with runners returning to their original bases, the batter will be called out, and the team manager will be EJECTED. NO WARNING will be given in this situation. **Exception: No penalty will be assessed when the bases loaded with two outs and full count on the batter.**

6.07 –**BATTING OUT OF TURN**

(a) A batter shall be called out, on appeal, when failing to bat in proper turn, and another batter completes a time at bat in place of the proper batter. (1) The proper batter may take position in the batter's box at any time before the improper batter becomes a runner or is put out, and any balls and strikes shall be counted in the proper batter's time at bat.

(b) When an improper batter becomes a runner or is put out, and the defensive team appeals to the umpire before the first pitch to the next batter of either team, or before any play or attempted play, the umpire shall (1) declare the proper batter out; and (2) nullify any advance or score made because of a ball batted by the improper batter or because of the improper batter's advance to first base on a hit, an error, a base on balls, a hit batter or otherwise.

**NOTE:** If a runner advances, while the improper batter is at bat, on a stolen base, balk, wild pitch or passed ball, such advance is legal.

(c) When an improper batter becomes a runner or is put out, and a pitch is made to the next batter of either team before an appeal is made, the improper batter thereby becomes the proper batter, and the results of such time at bat become legal.

(d) (1) When the proper batter is called out for failing to bat in turn, the next batter shall be the batter whose name follows that of the proper batter thus called out; (2) When an improper batter becomes a proper batter because no appeal is made before the next pitch, the next batter shall be the batter whose name follows that of such legalized improper batter. The instant an improper batter's actions are legalized, the batting order picks up with the name following that of the legalized improper batter.

**NOTE 1:** The umpire shall not direct the attention of any person to the presence in the batter's box of an improper batter. This rule is designed to require constant vigilance by the players, managers, and coaches of both teams.



**NOTE 2:** There are two fundamentals to keep in mind: When a player bats out of turn, the proper batter is the player called out. If an improper batter bats and reaches base or is out and no appeal is made before a pitch to the next batter, or before any play or attempted play, that improper batter is considered to have batted in proper turn and establishes the order that is to follow.

### **APPROVED RULINGS**

To illustrate various situations arising from batting out of turn, assume a first inning batting order as follows:

Abel-Baker-Charles-Daniel-Edward-Frank-George-Henry-Irwin.

PLAY (1). Baker bats. With the count 2 balls and 1 strike, (a) the offensive team discovers the error or (b) the defensive team appeals.

RULING: In either case, Abel replaces Baker, with the count 2 balls and 1 strike.

PLAY (2). Baker bats and doubles. The defensive team appeals (a) immediately or (b) after a pitch to Charles.

RULING: Abel is called out and Baker is the proper batter; (b) Baker stays on second and Charles is the proper batter.

PLAY (3). Abel walks. Baker walks. Charles forces Baker. Edward bats in Daniel's turn. While Edward is at bat, Abel scores and Charles goes to second on a wild pitch. Edward grounds out, sending Charles to third. The defensive team appeals (a) immediately or (b) after a pitch to Daniel.

RULING: (a) Abel's run counts and Charles is entitled to second base since these advances were not made because of the improper batter batting a ball or advancing to first base. Charles must return to second base because the advance to third resulted from the improper batter batting a ball. Daniel is called out and Edward is the proper batter; (b) Abel's run counts and Charles stays on third. The proper batter is Frank.

PLAY (4). With the bases full and two out, Henry bats in Frank's turn, and triples, scoring three runs. The defensive team appeals (a) immediately or (b) after a pitch to George. RULING: (a) Frank is called out and no runs score. George is the proper batter to lead off the second inning; (b) Henry stays on third and three runs score. Irwin is the proper batter.

PLAY (5). After Play (4) (b) above, George continues to bat. (a) Henry is picked off third base for the third out, or (b) George flies out, and no appeal is made. Who is the proper leadoff batter in the second inning?

RULING: (a) Irwin became the proper batter as soon as the first pitch to George legalized Henry's triple; (b) Henry. When no appeal was made, the first pitch to the lead-off batter of the opposing team legalized George's time at bat.

PLAY (6). Daniel walks and Abel comes to bat. Daniel was an improper batter and if an appeal is made before the first pitch to Abel, Abel is out, Daniel is removed from base, and Baker is proper batter. There is no appeal, and a pitch is made to Abel. Daniel's walk is now legalized, and Edward thereby becomes the proper batter. Edward can replace Abel at any time before Abel is put out or becomes a runner.

Edward does not do so. Abel flies out, and Baker comes to bat. Abel was an improper batter, and if an appeal is made before the first pitch to Baker, Edward is out, and the proper batter is Frank. There is no appeal, and a pitch is made to Baker. Abel's out is now legalized, and the proper batter is Baker. Baker walks. Charles is the proper batter. Charles flies out. Now Daniel is the proper batter, but Daniel is on second base. Who is the proper batter? RULING: The proper batter is Edward. When the proper batter is

on base, that batter is passed over, and the following batter becomes the proper batter.

6.08 –The batter becomes a runner and is entitled to first base without liability to be put out (provided said runner advances to and touches first base) when–

(a) Four “balls” have been called by the umpire;

(b) An Intentional Base on Balls is requested by the defensive team (Dead Ball)

(c) The batter is touched by a pitched ball which the batter is not attempting to hit unless (1) The ball is in the strike zone when it touches the batter, or (2) The batter makes no attempt to avoid being touched by the ball;

**NOTE:** If the ball is in the strike zone when it touches the batter, it shall be called a strike, whether or not the batter tries to avoid the ball. If the ball is outside the strike zone when it touches the batter, it shall be called a ball if that batter makes no attempt to avoid being touched.

**APPROVED RULING:** When the batter is touched by a pitched ball which does not entitle that batter to first base, the ball is dead, and no runner may advance.

(d) The catcher or any fielder interferes with the batter. If a play follows the interference, the manager of the offense may advise the plate umpire of a decision to decline the interference penalty and accept the play. Such election shall be made immediately at the end of the play. However, if the batter reaches first base on a hit, an error, a base on balls, a hit batsman, or otherwise, and all other runners advance at least one base, the play proceeds without reference to the interference.

**COMMENT:** If catcher’s interference is called with a play in progress the umpire will allow the play to continue because the manager may elect to take the play.

(e) A fair ball touches an umpire or a runner on fair territory before touching a fielder. **NOTE:** If a fair ball touches an umpire after having passed a fielder other than the pitcher, or having touched a fielder, including the pitcher, the ball is in play.

6.09 –The batter becomes a runner when–

(a) A fair ball is hit;

(b) (“O” Zone Division ONLY) The third strike called by the umpires is not caught, providing (1) first base is unoccupied or (2) when first base is occupied with two outs. When a batter becomes a base runner on a third strike not caught by the catcher and starts for the dugout or his position, and then realizes his situation and attempts then to reach first base, he is not out unless he or first base is tagged before he reaches first base. If, however, he actually reaches the dugout or dugout steps, he may not then attempt to go to first base and shall be called out.

(c) A fair ball, after having passed a fielder other than the pitcher, or after having been touched by a fielder or the pitcher, shall touch an umpire or runner on fair territory;

(d) A fair fly ball passes over a fence or into the stands at a distance from home base of 180 feet or more. Such hit entitles the batter to a home run when all bases have been legally touched. A fair fly ball that passes out of the playing field at a point less than 180 feet from home base shall entitle the batter to advance to second base only;

(e) A fair ball, after touching the ground, bounds into the stands, or passes through, over or under a fence, or through or under a scoreboard, or through or under shrubbery, or vines on the fence; the batter and runners shall be entitled to advance two bases;

(f) Any fair ball which, either before or after touching the ground, passes through or under a fence, or through or under a scoreboard, or through any opening in the fence or scoreboard, or through or under shrubbery or vines on the fence or which sticks in a fence or scoreboard in which case the batter and the runners shall be entitled to two bases;

(g) Any bounding fair ball is deflected by the fielder into the stands, or over or under a fence on fair or foul territory, in which case the batter and all runners shall be entitled to advance two bases;

(h) Any fair fly ball is deflected by the fielder into the stands, or over the fence into foul territory, in which case the batter shall be entitled to advance to second base; but if deflected into the stands or over the fence in fair territory, the batter shall be entitled to a home run. However, should such a fair fly be deflected at a point less than 180 feet from home plate, the batter shall be entitled to two bases only.

#### 7.00—THE RUNNER

7.01—A runner acquires the right to an unoccupied base when that runner touches it before being put out. The runner is then entitled to it until put out or forced to vacate it for another runner legally entitled to that base.

7.02—In advancing, a runner shall touch first, second, third and home base in order. If forced to return, the runner shall retouch all bases in reverse order, unless the ball is dead under any provision of Rule 5.09. In such cases, the runner may go directly to the original base.

7.03—Two runners may not occupy a base, but if, while the ball is alive, two runners are touching the base, the following runner shall be out when tagged. The preceding runner is entitled to the base.

7.04—Each runner, other than the batter, may, without liability to be put out, advance one base when—

(a) There is a balk (“O”Zone play only);

(b) The batter’s advance without liability to be put out forces the runner to vacate his base, or when the batter hits a fair ball that touches another runner or the umpire before such ball has been touched by, or has passed a fielder, if the runner is forced to advance; COMMENT: A runner forced to advance without liability to be put out may advance past the base to which he is entitled only at his peril. If such a runner, forced to advance, is put out for the third out before a preceding runner, also forced to advance, touches home plate, the run shall score. Play. Two out, bases full, batter walks but runner from second is overzealous and runs past third base toward home and is tagged out on a throw by the catcher. Even though two are out, the run would score on the theory that the run was forced home by the base on balls and that all the runners needed to do was proceed and touch the next base;

(c) A fielder, after catching a fly ball, falls into a bench or stand, or falls across ropes into a crowd when spectators are on the field;

(d) While he is attempting to steal a base, the batter is interfered with by the catcher or any other fielder;

(e) Two bases, if a fielder deliberately throws his glove at and touches a thrown ball. The ball is in play;

**NOTE:** When a runner is entitled to a base without liability to be put out, while the ball is in play, or under any rule in which the ball is in play after the runner reaches an entitled base, and the runner fails to touch the base to which that runner is entitled before attempting to advance to the next base, the runner shall forfeit the exemption from liability to be put out and may be put out by tagging the base or by tagging the runner before that runner returns to the missed base.

7.05—Each runner including the batter-runner may, without liability to be put out, advance—

(a)(1) To home base scoring a run if the batter hits a fair fly ball over the fence or into the bleachers 180 feet or more from home plate, provided all runners touch all bases legally; or if a fair ball which in the umpire's judgment would have gone out of the playing field in flight is deflected by an act of the fielder in throwing a glove, cap or any article of apparel. (Application of this rule is subject to Rule 7.13.) The batter hitting the home run shall be required to run the bases and he shall be required to touch all bases.

(a)(2) Two bases if the batter hits a fly ball that passes over a fence less than 180 feet from home plate. The ball is dead.

**NOTE:** DYB recommends that the home run fence be placed at a minimum distance of 200 feet (Majors / "O" Zone), or 180 feet (AAA & Below) from home plate.

(b) Three bases, if a fielder deliberately touches a fair ball with a cap, mask or any part of that fielder's uniform detached from its proper place on the fielder. The ball is in play and the batter may advance to home plate at the batter's peril;

(c) Three bases, if a fielder deliberately throws a glove and touches a fair ball. The ball is in play and batter may advance to home plate at that batter's own peril;

(d) Two bases, if a fielder deliberately touches a thrown ball with a cap, mask or any part of the uniform detached from its proper place on the person of said fielder. The ball is in play;

(e) Two bases, if a fielder deliberately throws a glove at and touches a thrown ball. The ball is in play;

**COMMENT:** In applying (b-c-d-e) the umpire must rule that the thrown glove or detached cap or mask has touched the ball. There is no penalty if the ball is not touched. Under (c-e) this penalty shall not be invoked against a fielder whose glove is carried off his hand by the force of a batted or thrown ball, or when his glove flies off his hand as he makes an obvious effort to make a legitimate catch.

(f) Two bases, if a fair ball bounces or is deflected into the stands outside the first or third base foul line; or if it goes through or under a field fence, or through or under a scoreboard, or through or under shrubbery or vines on the fence; or if it sticks in such fence, scoreboard, shrubbery or vines;

(g) Two bases when, with no spectators on the playing field, a thrown ball goes into the stands, or into a bench (whether or not the ball rebounds into the field), or over or under or through a field fence, or on a slanting part of the screen above the backstop, or remains in the meshes of a wire screen protecting the spectators. The ball is dead. When such wild throw is the first play by an infielder, the umpire, in awarding such bases, shall be governed by the position of the runners at the time the ball was pitched; in all other cases, the umpire shall be governed by the position of the runners at the time the wild throw was made;

**APPROVED RULING:** If all runners, including the batter-runner, have advanced at least one base when the infielder makes a wild throw on the first play after the pitch, the award shall be governed by the position of the runners when the wild throw is made.

(h) One base, if a ball, pitched to the batter, or thrown by the pitcher from the position on the pitcher's plate to a base to catch a runner goes into a stand or a bench, or over or through a field fence or backstop. The ball is dead;

(i) One base, if the batter becomes a runner on a ball four, or strike three in "O"Zone play, when the pitch passes the catcher and lodges in the umpire's mask or paraphernalia. **NOTE:** If the batter becomes a runner on a wild pitch which entitles the runners to advance one base, the batter-runner shall be entitled to first base only.

7.06—When obstruction occurs, the umpire shall call or signal "Obstruction."

(a) If a play is being made on the obstructed runner, or if the batter-runner is obstructed before touching first base, the ball is dead and all runners shall advance without liability to be put out, to the bases they would have reached, in the umpire's judgment, if there had been no obstruction. The obstructed runner shall be awarded at least one base beyond the base last legally touched by such runner, before the obstruction. Any preceding runners forced to advance by the award of bases as the penalty for obstruction shall advance without liability to be put out;

**COMMENT:** When a play is being made on an obstructed runner, the umpire shall signal obstruction in the same manner that he calls "Time," with both hands overhead. The ball is immediately dead when this signal is given; however, should a thrown ball be in flight before the obstruction is called by the umpire, the runners are to be awarded such bases on wild throws as they would have been awarded had not obstruction occurred. On a play where a runner was trapped between second and third and obstructed by the third baseman going into third base while the throw is in flight from the shortstop, if such throw goes into the dugout the obstructed runner is to be awarded home base. Any other runners on base in this situation would also be awarded two bases from the base they last legally touched before obstruction was called.

(b) If no play is being made on the obstructed runner, the play shall proceed until no further action is possible. The umpire shall then call "Time" and impose such penalties, if any as in that umpire's judgment will nullify the act of obstruction. **COMMENT:** Under 7.06(b) when the ball is not dead on obstruction and an obstructed runner advances beyond the base which, in the umpire's judgment, he would have been awarded because of being obstructed, he does so at his own peril and may be tagged out. This is a judgment call. **NOTE:** The catcher, without the ball in his possession, has no right to block the pathway of the runner attempting to score. The base line belongs to the runner and the catcher should be there only when he is fielding a ball or when he has the ball in his hand.

7.07 – ("**O**"Zone Play Only) - If, with a runner on third base and trying to score by means of a squeeze play or a steal, the catcher or any other fielder steps on, or in front of home base without possession of the ball, or touches the batter or his bat, the pitcher shall be charged with a balk, the batter shall be awarded first base on the interference and the ball is dead.

7.08—**Any runner is out when—**

(a) (1) the runner runs more than three feet away from a direct line between bases to avoid being tagged, unless such action is to avoid interference with a fielder fielding a batted ball; or (2) after touching first base the runner leaves the baseline, obviously abandoning all effort to touch the next base;

(b) Intentionally interferes with a thrown ball; or hinders a fielder attempting to make a play on a batted ball; **COMMENT:** A runner who is adjudged to have hindered a fielder who is attempting to make a play on a batted ball is out whether it was intentional

or not. If, however, the runner has contact with a legally occupied base when he hinders the fielder, he shall not be called out unless, in the umpire's judgment, such hindrance, whether it occurs on fair or foul territory, is intentional. If the umpire declares the hindrance intentional, the following penalty shall apply: With less than two out, the umpire shall declare both the runner and batter out. With two out, the umpire shall declare the batter out. If, in a run-down between third base and home plate, the succeeding runner has advanced and is standing on third base when the runner in a run-down is called out for offensive interference, the umpire shall send the runner standing on third base back to second base. This same principle applies if there is a run-down between second and third base and succeeding runner has reached second (the reasoning is that no runner shall advance on an interference play and a runner is considered to occupy a base until he legally has reached the next succeeding base).

(c) The runner is tagged, when the ball is alive, while off a base; **EXCEPTION:** A batter-runner cannot be tagged out after overrunning or over sliding first base if said batter-runner returns immediately to the base.

#### **APPROVED RULINGS:**

(1) If the impact of a runner breaks a base loose from its position, no play can be made on that runner at that base if the runner had reached the base safely.

(2) If a base is dislodged from its position during a play, any following runner on the same play shall be considered as touching or occupying the base if, in the umpire's judgment, that runner touches or occupies the point marked by the dislodged bag.

(d) the runner fails to retouch his or her base after a fair or foul fly ball is legally caught before that runner or the base is tagged by a fielder. The runner shall not be called out for failure to retouch the base after the first following pitch, or any play or attempted play. This is an appeal play;

(e) the runner fails to reach the next base before a fielder tags said runner or the base after that runner has been forced to advance by reason of the batter becoming a runner. However, if a following runner is put out on a force play, the force is removed, and the runner must be tagged to be put out. The force is removed as soon as the runner touches the base to which that runner is forced to advance, and if over sliding or overrunning the base, the runner must be tagged to be put out. However, if the forced runner, after touching the next base, retreats for any reason towards the base last occupied, the force play is reinstated, and the runner can again be put out if the defense tags the base to which the runner is forced;

(f) The runner is touched by a fair ball in fair territory before the ball has touched or passed an infielder. The ball is dead, and no runner may score, no runners advance, except runners forced to advance; **EXCEPTION:** If a runner is touching a base when touched by an Infield Fly, that runner is not out, although the batter is out;

**NOTE:** If two runners are touched by the same fair ball, only the first one is out because the ball is instantly dead.

(g) the runner attempts to score on a play in which the batter interferes with the play at home base before two are out. With two out, the interference puts the batter out and no score counts;

(h) the runner passes a preceding runner before such runner is out;

(i) After acquiring legal possession of a base, the runner runs the bases in reverse order for the purpose of confusing the defense or making a travesty of the game. The umpire shall immediately call "Time" and declare the runner out;

**COMMENT:** If a runner touches an unoccupied base and then thinks the ball was caught or is decoyed into returning to the base he last touched, he may be put out running back to that base, but if he reaches the previously occupied base safely, he cannot be put out while in contact with that base.

(j) the runner fails to return at once to first base after overrunning or over sliding that base. If attempting to run to second, the runner is out when tagged. If after overrunning or over sliding first base, the runner starts toward the dugout, or toward a position, and fails to return to first base at once, that runner is out on appeal, when said runner or the base is tagged; **COMMENT:** Runner who touches first base in overrunning and is declared safe by the umpire has, within the intent of Rule 4.09(a) “reached first base” and any run which scores on such a play counts, even though the runner subsequently becomes the third out for failure to return “at once,” as covered in Rule 7.08(j);

(k) In running or sliding for home base, the runner fails to touch home base and makes no attempt to return to the base, when a fielder holds the ball in hand, while touching home base, and appeals to the umpire for the decision;

(l) A runner wearing a full-face mask, while attempting to reach the next base, attempts a head-first slide. **NOTE: This shall apply only to a runner wearing a full-face mask attempting to reach the next base and does not apply to a dive or attempt to return to a base;**

(m) The runner does not slide or attempt to get around a fielder who has the ball and is waiting to make the tag; **NOTE:** The ball is dead and other base runners take bases they had reached, in the umpire’s judgment, when the violation occurred.

#### 7.09—It is interference by a batter or a runner when—

(a) After a third strike the batter hinders the catcher in an attempt to field the ball;

(b) After hitting or bunting a fair ball, while holding the bat, the bat of such batter hits the ball a second time in fair territory. The ball is dead, and no runners may advance. If the batter-runner drops the bat and the ball rolls against the bat in fair territory and, in the umpire’s judgment, there was no intention to interfere with the course of the ball, the ball is alive and in play;

(c) The batter intentionally deflects the course of a foul ball in any manner;

(d) Before two are out and a runner on third base, the batter hinders a fielder making a play at home base; the runner is out;

(e) Any member or members of the offensive team stand or gather around any base to which a runner is advancing, to confuse, hinder or add to the difficulty of the fielders. Such runner shall be declared out for the interference of teammate or teammates;

(f) Any batter or runner who has just been put out, or any runner who has just scored, hinders or impedes any following play being made on a runner. Such runner shall be declared out for the interference of a teammate;

(g) If, in the judgment of the umpire, a base runner willfully and deliberately interferes with a batted ball or a fielder in the act of fielding a batted ball with the obvious intent to break up a double play, the ball is dead. The umpire shall call the runner out for interference and also call out the batter-runner because of the action of the runner. In no event may bases be run or runs scored because of such action by a runner;

(h) If, in the judgment of the umpire, a batter-runner willfully and deliberately interferes with a batted ball or a fielder in the act of fielding a batted ball, with the obvious intent to break up a double play, the ball is dead; the umpire shall call the batter-runner out for interference and shall also call out the runner who advanced

closest to the home plate regardless where the double play might have been possible. In no event shall bases be run because of such interference;

(i) In the judgment of the umpire, the base coach at third base, or first base, by touching or holding the runner, physically assists that runner in returning to or leaving third base or first base;

(j) With a runner on third base, the base coach leaves the box and acts in any manner to draw a throw by a fielder;

(k) In running the last half of the distance from home base to first base while the ball is being fielded to first base, the batter-runner runs outside (to the right of) the three-foot line, or inside (to the left of) the foul line and, in the umpire's judgment, interferes with the fielder taking the throw at first base or attempting to field a batted ball;

(l) The runner fails to avoid a fielder who is attempting to field a batted ball, or intentionally interferes with a thrown ball, provided that if two or more fielders attempt to field a batted ball, and the runner comes in contact with one or more of them, the umpire shall determine which fielder is entitled to the benefit of this rule, and shall not declare the runner out for coming in contact with a fielder other than the one the umpire determines to be entitled to field such a ball;

(m) A fair ball touches the batter or runner in fair territory before touching a fielder. If a fair ball goes through or by an infielder and touches a runner immediately back of said infielder or touches the runner after having been deflected by a fielder, the umpire shall not declare the runner out for being touched by a batted ball. In making such decision, the umpire must be convinced that the ball passed through or by the infielder and that no other infielder had the chance to make a play on the ball. If in the judgment of the umpire, the runner deliberately and intentionally kicks such a batted ball on which the infielder had missed a play, then the runner shall be called out for interference. **INTERFERENCE PENALTY:** The runner is out, and the ball is dead.

7.10—Appeals—Any runner shall be called out on appeal, when—

(a) After a fly ball is caught, the runner fails to retouch the base before said runner or base is tagged;

(b) With the ball in play, the runner, while advancing or returning to a base, fails to touch each base in order before the said runner or base is tagged;

**APPROVED RULING:** (1) No runner may return to touch a missed base after a following runner has scored. (2) When the ball is dead, no runner may return to touch a missed base, or one abandoned after said runner has advanced to and touched a base beyond the missed base.

(c) The runner overruns or over slides first base and fails to return to the base immediately, and said runner or the base is tagged; or,

(d) The runner fails to touch home base and makes no attempt to return to that base, and home base is tagged.

#### **APPEAL PROCEDURE:**

(1) Any appeal under this rule must be made before the next pitch, or any play or attempted play. An appeal is not to be interpreted as a play or an attempted play; If the base running violation occurs during a play which ends a half-inning, the appeal must be made before the defensive team leaves the field. (The defensive team has left field when no players remain in fair territory);

(2) A time out may be granted either team before an appeal play is made. If the defensive team makes an appeal during a time out, the umpire shall instruct the team to put the ball in play and make the appeal again;



(3) The appeal shall be made while the ball is alive (in play) and runners are free to advance while the appeal is being made. When the ball is dead, it becomes alive again when the pitcher has the ball and is on the rubber and the umpire says “play”;

(4) An appeal shall be clearly intended as an appeal, either by verbal request by the player or an act that unmistakably indicates an appeal to the umpire;

(5) If the defensive team on its first appeal “errs,” a request for a second appeal on the same runner at the same base shall not be allowed by the umpire. (The intended meaning of the word “err” is that the defensive team in making the appeal threw the ball out of play. For example, if the pitcher threw to first base to appeal and threw the ball into the dugout or into the stands, no second appeal would be allowed. If the ball merely went into foul territory, the defensive team could retrieve the ball and make a second appeal at the same base on the runner);

(6) If a player is confused and appeals to the wrong base, the defense can still appeal to the proper base;

(7) Appeal plays may require an umpire to recognize an apparent “fourth out.” If the third out is made during a play in which an appeal play is sustained on another runner, the appeal play decision takes precedence in determining the out;

(8) If there is more than one appeal during a play that ends a half-inning, the defense may elect to take the out that gives it the advantage;

(9) If two runners arrive at home base about the same time and the first runner misses home plate but a second runner legally touches the plate, and the first runner is tagged out on his attempt to come back and touch home base or is called out on appeal, then, the first runner shall be considered to have been put out before the second runner. If the out called on the first runner was the third out, then, the second runner would not score.

7.11—The players, coaches or any member of an offensive team shall vacate any space (including both dugouts) needed by a fielder who is attempting to field a batted or thrown ball. **PENALTY:** Interference shall be called and the batter or runner on whom the play is being made shall be declared out.

7.12—Unless two are out, the status of a following runner is not affected by a preceding runner’s failure to touch or retouch a base. If, upon appeal, the preceding runner is the third out, no runners following the preceding runner shall score. If such third out is the result of a force play, neither preceding nor following runners shall score.

7.13—(a) When a pitcher is in contact with the pitcher’s plate with the ball in his possession, and the catcher is in the catcher’s box in position to receive the pitch, all runners shall be in contact with their bases and shall not leave their bases until the pitch has reached the plate.

(b) If a runner leaves the base before the pitch reaches the plate, the base umpire shall drop a signal flag to indicate the violation at the time it occurs.

**PENALTY:** The defensive team shall have the privilege of nullifying any portion of the play that occurred after the violation. **EXCEPTION:** Penalty does not apply when:

(1) the batter hits a ground rule double; all runners will advance two bases without liability to be put out.

(2) the batter hits a fly ball over the outfield fence in fair territory (homerun); all runners will be allowed to score.

(3) the batter is hit by a pitched ball; the ball is dead, and all other runners will not advance unless forced to vacate the base for another runner legally entitled to that base.

**NOTE:** This rule shall not apply to the “O Zone” (open base) division play.

## 8.00—THE PITCHER

### 8.01—LEGAL PITCHING DELIVERY

There are two legal pitching positions, the Windup Position and the Set Position, and either position may be used at any time. Pitchers shall take signs from the catcher or from the dugout while standing on the rubber. Pitchers may disengage the rubber after taking their signs but may not step quickly onto the rubber and pitch. This may be judged a quick pitch by the umpire. When the pitcher disengages the rubber, he must drop his hands to his sides. Pitchers will not be allowed to disengage the rubber after taking each sign.

#### (a) THE WINDUP POSITION

(1) The pitcher shall stand facing the batter, his pivot foot in contact with the pitcher's plate, and the other foot free. From this position any natural movement associated with his delivery of the ball to the batter commits him to the pitch without interruption or alteration. He shall not raise either foot from the ground, except that in his actual delivery of the ball to the batter, he may take one step backward, and one step forward with his free foot.

(2) When a pitcher holds the ball with both hands in front of his body, with his pivot foot in contact with the pitcher's plate and his other foot free, he will be considered in the Windup Position.

(3) In the Windup position, a pitcher is permitted to have his "free" foot on the rubber, in front of the rubber, behind the rubber or off the side of the rubber.

(4) From the Windup Position, the pitcher may:

(i) deliver the ball to the batter, or

(ii) step and throw to a base in an attempt to pick-off a runner, or

(iii) disengage the rubber (if he does, he must drop his hand to his sides).

In disengaging the rubber, the pitcher must step off with his pivot foot and not his free foot first. He may not go into a Set position stance from the Windup stance or from the Windup stance to the Set position stance without disengaging the rubber - if he does it is a balk.

#### (b) THE SET POSITION

(1) The Set Position shall be indicated by the pitcher when he stands facing the batter with his pivot foot in contact with, and his other foot in front of the pitcher's plate, holding the ball in both hands in front of his body and coming to a complete stop.

(2) From such Set Position, he may deliver the ball to the batter, throw to a base or step backward off the pitcher's plate with his pivot foot;

(3) Before assuming the Set position, the pitcher may elect to make any natural preliminary motion such as that known as "the stretch". However, if he so elects, he shall come to the Set Position before delivering the ball to the batter. After assuming the Set position, any natural motion associated with his delivery of the ball to the batter commits him to the pitch without alteration or interruption;

(4) Prior to coming to a set position, the pitcher will be allowed to turn his shoulder to check the runner(s) on base and the pitcher shall have one hand on his side: from this position, he shall go to his set position without interruption and in one continuous motion;

(5) The pitcher, following his stretch, must (a) hold the ball in both hands in front of his body and (b) come to a complete stop. This must be enforced. Pitchers are constantly

attempting to “beat the rule” in their efforts to hold runners on bases and in cases where the pitcher fails to make a complete “stop” called for in the rules, the umpire should immediately call a “Balk”. NOTE: With no runners on base, the pitcher is not required to come to a complete stop when using the Set position. If, however, in the umpire’s judgement, a pitcher delivers the ball in a deliberate effort to catch the batter off guard, this delivery shall be deemed a quick pitch, for which the penalty is a ball;

(6) At any time during the pitcher’s preliminary movements and until his natural pitching motion commits him to the pitch, he may throw to any base provided he steps directly toward such base before making the throw. Stepping at a 45- degree angle is acceptable. For instance, stepping directly toward a base is considered acceptable if the pitcher steps at a 45- degree angle between the center of pitcher’s plate and between home and first base;

(7) The pitcher shall step “ahead of the throw”. A snap throw followed by the step directly toward the base is a balk;

(8) If the pitcher makes an illegal pitch with the bases unoccupied, it shall be called a ball unless the batter reaches first base on a hit, an error, a base on balls, a hit batter or otherwise;

(9) A ball that slips out of a pitcher’s hand and crosses the foul line shall be called a ball; otherwise it will be called a no pitch. This would be a balk with men on base in “O”Zone play;

(10) If the pitcher removes his pivot foot from contact with the pitcher’s plate by stepping backward with that foot, he thereby becomes an infielder and if he makes a wild throw from that position, it shall be considered the same as a wild throw by any other infielder. The pitcher, while off the rubber, may throw to any base. If he makes a wild throw, such throw is the throw of an infielder and what follows is governed by the rules covering a ball thrown by a fielder.

#### **8.02–(a) The pitcher shall not-**

(1) While in the 12-foot circle surrounding the pitcher’s plate, touch the ball after touching his mouth or lips, or touch his mouth or lips while he is in contact with the pitcher’s plate. The pitcher must clearly wipe the fingers of his pitching hand dry before touching the ball or the pitcher’s plate;

(2) Apply a foreign substance of any kind to the ball;

(3) Spit on the ball, either hand or his glove;

(4) Rub the ball on his glove, person or clothing;

(5) Deface the ball in any manner;

(6) Have on his person, or in his possession any foreign substance;

(7) Deliver a “quick” return pitch.

**NOTE:** The pitcher, of course, is allowed to rub the ball between his bare hands.

**PENALTY: For violation of this part of rule 8.02(a), the umpire shall:**

(i) Immediately call the pitch a ball;

(ii) However, if the pitch is made and a batter reaches first base on a hit, an error, a hit batsman, or otherwise, and no other runner is put out before advancing at least one base, the play shall proceed without reference to the violation.

(iii) Even though the offense elects to take the play, the violation shall be recognized, and the umpire will ask that the pitcher be removed from the mound. In the judgment of the umpire, the pitcher did not intend, by his act, to alter the characteristics of a pitched ball, then the umpire will warn the pitcher in lieu of

removing the pitcher from the mound. If the pitcher persists in violating the rules, the umpire shall apply the penalty (remove the pitcher from the mound).

(iv) The umpire shall be sole judge on whether any portion of this rule has been violated. The Umpire-In-Chief shall inspect and approve one official rosin bag. The umpire in chief is responsible for placing the rosin bag on the ground back of the pitcher's plate. If at any time the ball hits the rosin bag it is in play. In the case of rain or wet field, the umpire may instruct the pitcher to carry the rosin bag in his hip pocket. A pitcher may use the rosin bag for the purpose of applying rosin to his bare hand or hands. Neither the pitcher nor any other player shall dust the ball with the rosin bag; neither shall the pitcher nor any other player be permitted to apply rosin from the bag to his glove or dust any part of his uniform with the rosin bag.

(b) Intentionally delay the game by throwing the ball to players other than the catcher, when the batter is in position, except in an attempt to retire a runner; **PENALTY:** If, after warning by the umpire, such delaying action is repeated, the pitcher shall be ejected from the game.

(c) Intentionally Pitch at the Batter. If, in the umpire's judgment, such a violation occurs, the umpire may elect either to: (i) Expel the pitcher, or the manager and the pitcher, from the game, or (ii) may warn the pitcher and the manager of both teams that another such pitch will result in the immediate expulsion of that pitcher (or a replacement) and the manager. If, in the umpire's judgment, circumstances warrant, both teams may be officially "warned" prior to the game or at any time during the game. To pitch at a batter's head is unsportsmanlike and highly dangerous. It should be and is condemned by everybody. Umpires should act without hesitation in enforcement of this rule.

8.03—When a pitcher takes his position at the beginning of each inning, or when he relieves another pitcher, he shall be permitted to pitch not to exceed eight preparatory pitches to his catcher during which play shall be suspended. A league by its own action may limit the number of preparatory pitches to less than eight preparatory pitches. Such preparatory pitches shall not consume more than one minute of time. If a sudden emergency causes a pitcher to be summoned into the game without any opportunity to warm up, the umpire in chief shall allow him as many pitches as the umpire deems necessary.

8.04—When the bases are unoccupied, the pitcher shall deliver the ball to the batter within 20 seconds after he receives the ball. Each time the pitcher delays the game by violating this rule, the umpire shall call "Ball." The intent of this rule is to avoid unnecessary delays. The umpire shall insist that the catcher return the ball promptly to the pitcher, and that the pitcher take his position on the rubber promptly. Obvious delay by the pitcher should instantly be penalized by the umpire.

8.05—If there is a runner, or runners, it is a balk when -

(a) The pitcher, while touching his plate, makes any motion naturally associated with his pitch and fails to make such delivery. If a left-handed or right-handed pitcher swings his free foot past the back edge of the pitcher's rubber, he is required to pitch to the batter except to throw to second base on a pick-off play;

(b) ("O"Zone Play Only) The pitcher, while touching his plate, feints a throw to first or third base and fails to complete the throw;

(c) ("O"Zone Play Only) The pitcher, while touching his plate, fails to step direct toward a base before throwing to that base;

**COMMENT:** Requires the pitcher, while touching his plate, to step directly toward a base before throwing to that base. If a pitcher turns or spins off of his free foot without actually stepping or if he turns his body and throws before stepping, it is a balk. A pitcher is to step directly toward a base before throwing to that base and is required to throw (except to second base) because he steps. It is a balk if, with runners on first and third, the pitcher steps toward third and does not throw, merely to bluff the runner back to third; then seeing the runner on first start for second, turn and step toward and throw to first base. It is legal for a pitcher to feint a throw to second base.

(d) The pitcher, while touching his plate, throws, or feints a throw to an unoccupied base, except for the purpose of making a play;

(e) The pitcher makes an illegal pitch; A quick pitch is an illegal pitch. Umpires will judge a quick pitch as one delivered before the batter is reasonably set in the batter's box. With runners on base the penalty is a balk; with no runners on base, it is a ball. The quick pitch is dangerous and should not be permitted;

(f) The pitcher delivers the ball to the batter while he is not facing the batter;

(g) The pitcher makes any motion naturally associated with his pitch while he is not touching the pitcher's plate;

(h) The pitcher unnecessarily delays the game;

(i) The pitcher, without having the ball, stands on or astride the pitcher's plate or while off the plate, he feints a pitch;

(j) The pitcher, after coming to a legal pitching position, removes one hand from the ball other than in an actual pitch, or in throwing to a base;

(k) The pitcher, while touching his plate, accidentally or intentionally drops the ball;

(l) The pitcher, while giving an intentional base on balls, pitches when the catcher is not in the catcher's box;

(m) The pitcher delivers the pitch from Set Position without coming to a stop.

**PENALTY:** Majors/AAA/AA Divisions — **NO PENALTY:** Any pitch or any action by the pitcher construed as a balk by the umpire shall be declared a no pitch. The ball is dead, and no runner shall advance.

**NOTE:** Any action by the batter or any member of the offensive team, including the coaches, that, in the opinion of the umpire-in-chief, causes a pitcher to commit an illegal pitch or balk shall result in the pitch being declared a no pitch. The ball shall be dead, and no runners shall advance.

**PENALTY:** "O"Zone Division — The ball is dead immediately. All runners on base shall be entitled to advance one base without liability to be put out.

**DYB APPROVED RULING:** In cases where a pitcher balks and throws wild, the ball is dead. The runner(s) are advanced in accordance with the "O" Zone balk rule.

**DYB APPROVED RULING:** A runner who misses the first base to which he is advancing and who is called out on appeal shall be considered as having advanced one base for the purpose of this rule. Umpires should bear in mind that the purpose of the balk rule is to prevent the pitcher from deliberately deceiving the base runner. If there is doubt in the umpire's mind, the "intent" of the pitcher should govern. However, certain specifics should be borne in mind: (a) Straddling the pitcher's rubber without the ball is to be interpreted as intent to deceive and ruled a balk. (b) With a runner on first base the pitcher may make a complete turn, without hesitating toward first, and throw to second. This is not to be interpreted as throwing to an unoccupied base.

8.06—The following rule governs the visit of the manager or coach to the pitcher or other defensive players:

- (a) This rule limits the number of visits a manager or coach may make to any one pitcher or other defensive players in any one inning;
- (b) A third visit during the same inning to talk to his defensive players while the same pitcher is on the mound will cause the pitcher's automatic removal from the mound but not the game;

**8.07—PITCHING Limitations (Regular Season Only)**—These pitching restrictions apply only to regular season play. Rule 8.07 is replaced in its entirety for tournament play by a completely new set of tournament pitching requirements.

### **Pitch Counts**

All players on a regular season team may pitch in any game during the regular season subject to the following limitations:

### **Pitch Count Limitations**

- (1) A League Age 10 and under pitcher shall not throw more than 75 pitches in a game or in a calendar day. Exception: If the pitcher reaches the daily pitch count limit while facing a batter, he may continue to pitch until the batter reaches base safely, is put out or, a third out is made on a base-runner to end the half-inning.
- (2) A League Age 11 or 12 pitcher shall not throw more than 85 pitches in a game or in a calendar day. Exception: If the pitcher reaches the daily pitch count limit while facing a batter, he may continue to pitch until the batter reaches base safely, is put out or, a third out is made on a base-runner to end the half-inning.
- (3) A pitcher shall be allowed to pitch in two or more games on the same calendar day provided he/she does not throw more than 30 cumulative pitches in the previous game or games on the same calendar day.
- (4) All pitchers in local league play must adhere to the following daily pitch count rest requirements:

| <b>League Age</b> | <b>No Rest</b> | <b>1 Day</b> | <b>2 Days</b> | <b>3 Days</b> |
|-------------------|----------------|--------------|---------------|---------------|
| 09-12             | 1-30           | 31-45        | 46-65         | 66+           |

**There are no exceptions to the rest period pitch count thresholds.**

**NOTE:** These pitching rest requirements are based on the number of pitches a player throws in a calendar day. If for any reason, a game ends after midnight, the pitches thrown in the game will be charged to the previous day. The pitcher begins his rest requirement at midnight when his total pitch count for the calendar day exceeds 30 pitches in one or more games.

- (5) **SUSPENDED GAMES** - In a game suspended by darkness, weather, or other causes and resumed on a following calendar day, the pitcher of record at the time the game was suspended may continue to pitch provided he/she had delivered 30 or less pitches on the calendar day the game was suspended. If the pitcher is eligible to return to the mound when the game is resumed, the pitcher's game pitch count limit will carryover, but the daily pitch count limit will be reset to zero.

### **Innings Limitations**

- (6) A pitcher shall not pitch more than six innings in the calendar week between from 12:01 a.m. Monday to 12:00 midnight the following Sunday. For the purposes of satisfying any portion of Rule 8.07(a), the pitching of one (1) pitch shall be counted as the pitching of one inning.

(7) The pitcher shall be charged only for the innings pitched. If a pitcher does not have to pitch the bottom half of an inning he is NOT charged for that inning. No innings pitched shall be charged to the pitchers that are listed in the batting order of both teams handed to the official scorer in games forfeited before actual play begins.

(8) A pitcher removed from the mound for any reason shall not return to the mound to pitch during the same game. Exception: A pitcher who delivers 41 or more pitches in a game cannot play the position of catcher for the remainder of the game. Any player who has played the position of catcher in four or more complete innings, (or, 12 outs) in a game is not eligible to pitch in that game.

(9) Local leagues that play regular season teams in a double elimination tournament bracket to decide a league championship or for a regular season local league tournament must use Tournament Pitching Rules in Tournament Rule VII.

### **Official Pitch Count Record**

(10) The local league must designate the scorekeeper or another game official as the official pitch count statistician for each game. The pitch count statistician shall record all pitches including strikes, balls, foul tips and any pitches delivered to the catcher ruled a “no pitch” by the umpire. The official pitch count statistician’s pitch count is the official pitch count and cannot be protested.

(11) The pitch count statistician must provide the current pitch count for any pitcher when requested by either manager or any umpire. However, the manager has the ultimate responsibility for knowing his pitcher’s pitch count at all times and when his/her pitcher must be removed to meet the rest requirements above.

(12) The official pitch count statistician shall inform the umpire-in-chief when a pitcher has delivered his/her maximum limit of pitches for the game, as noted above. The umpire-in-chief will inform the pitcher’s manager that the pitcher must be removed after the current batter reaches base safely or is put out. However, the failure by the pitch count statistician to notify the umpire-in-chief, and/or the failure of the umpire-in- chief to notify the manager, does not relieve the manager of his/her responsibility to remove a pitcher when that pitcher is no longer eligible.

(13) **Protests of an Illegal Pitcher and Penalty** shall be handled pursuant to Rule 3.03(c) Note: If the pitcher reached his pitch count daily maximum on a previous batter, the pitcher must be removed immediately upon discovery.

## **9.00 —THE UMPIRE**

9.01–(a) The league president shall appoint one or more umpires to officiate at each league game. The umpires shall be responsible for the conduct of the game in accordance with these official rules and for maintaining discipline and order on the playing field during the game.

(b) Each umpire is the representative of the league and DYB and is authorized and required to enforce all of these rules. Each umpire has authority to order a player, coach, manager or league officer to do or refrain from doing anything which affects the administration of these rules and to enforce the prescribed penalties.

(c) Each umpire has authority to rule on any point not specifically covered in these rules.

(d) Each umpire has authority to disqualify any player, coach, manager or substitute for objecting to decisions or for unsportsmanlike conduct or language and to eject such disqualified person from the playing field. If an umpire disqualifies a player while a play is in progress, the disqualification shall not take effect until no further action is possible in that play. The umpire shall be empowered to call a base runner

out or safe for an act either by him or by a fielder that in the opinion of the umpire is unsportsmanlike conduct.

(e) All umpires have authority at their discretion to eject from the playing field:

(1) any person whose duties permit that person's presence on the field, such as ground crew members, photographers, newsmen, broadcasting crew members, etc. and; (2) any spectator or other person not authorized to be on the playing field.

9.01–(a) Any umpire's decision which involves judgment, such as, but not limited to, whether a batted ball is fair or foul, whether a pitch is a strike or a ball, or whether a runner is safe or out, is final. No player, manager, coach or substitute shall object to any such judgment decisions.

(b) If there is reasonable doubt that any umpire's decision may be in conflict with the rules, the manager may appeal the decision and ask that a correct ruling be made. Such appeal shall be made only to the umpire who made the protested decision.

(c) If a decision is appealed, the umpire making the decision, may ask another umpire for information before making a final decision. No umpire shall criticize, seek to reverse or interfere with another umpire's decision unless asked to do so by the umpire making it.

(d) No umpire may be replaced during a game unless injured or ill.

9.02–(a) If there is only one umpire, that umpire shall have complete jurisdiction in administering the rules. This umpire may take any position on the playing field which will enable said umpire to discharge all duties (usually behind the catcher, but sometimes behind the pitcher if there are runners).

(b) If there are two or more umpires, one shall be designated umpire-in-chief and the others field umpires.

9.03–(a) The umpire-in-chief shall stand behind the catcher. This umpire usually is called the plate umpire. The duties of the umpire-in-chief shall be to:

(1) Take full charge of, and be responsible for, the proper conduct of the game;

(2) Call and count balls and strikes;

(3) Call and declare fair balls and fouls except those commonly called by field umpires;

(4) Make all decisions on the batter;

(5) Make all decisions except those commonly reserved for the field umpires;

(6) Decide when a game shall be forfeited;

(7) If a time limit has been established by the league, call the game after both teams have completed an equal number of innings unless the home team is ahead after the time limit expires;

(8) Inform the official scorer of the official batting order and any changes in the lineups and batting order, on request;

(9) Announce any special ground rules.

(b) A field umpire may take any position on the playing field best suited to make impending decisions on the bases. A field umpire's duties shall be to:

(1) Make all decisions on the bases except those specifically reserved to the umpire-in-chief;

(2) Take concurrent jurisdiction with the umpire-in-chief in calling "Time," balks, illegal pitches, or defacement or discoloration of the ball by any player;

(3) Aid the umpire-in-chief in every manner in enforcing the rules, and excepting the power to forfeit the game, shall have equal authority with the umpire-in-chief in administering and enforcing the rules and maintaining discipline.



(c) If different decisions should be made on one play by different umpires, the umpire-in-chief shall call all the umpires into consultation, with no manager or player present. After consultation, the umpire-in-chief (unless another umpire may have been designated by the league president) shall determine which decision shall prevail, based on which umpire was in best position and which decision was most likely correct. Play shall proceed as if only the final decision had been made.

9.04–(a) The umpire shall report to the league president within twenty-four hours after the end of a game all protests, violations of rules and other incidents worthy of comment, including the disqualification of any manager, coach or player and the reasons therefore.

(b) When any manager, coach or player is disqualified for a flagrant offense such as the use of obscene or indecent language, or an assault upon an umpire, manager, coach or player, the umpire shall forward full particulars to the league president within twenty-four hours after the end of the game.

(c) After receiving the umpire's report that a manager, coach or player has been disqualified, the league president shall require such manager, coach or player to explain his conduct. In the case of a player, the manager shall appear with the player in the capacity of an advisor. The local league shall impose such penalty as they feel is justified.

9.05–Umpires shall not wear shoes with metal spikes or cleats.

## 10.00 —THE OFFICIAL SCORER

10.01–(a) The league president should appoint an official scorer for each league game. The scorer shall have sole authority to make all decisions involving judgment, such as whether a batter's advance to first base is the result of a hit or an error. The scorer shall communicate such decisions to the press by hand signals or over the loudspeaker system and shall advise the public-address announcer of such decisions if requested. In the event of a question of eligibility of a pitcher, the record of the Official Scorer shall be deemed official. **NOTE:** When no official scorer has been appointed, the scorebook of the home team shall be the official record.

### (b) Scoring Records

(1) To achieve uniformity in keeping the records a league shall conform strictly to the Official Scoring Rules enumerated in Rule 10.00 of the Official Playing Rules of professional baseball. The scorer shall have authority to rule on any point not specifically covered in the Scoring Rules.

(2) If the teams change sides before three are put out, the scorer shall immediately inform the umpire of the mistake.

(3) If the game is protested or play suspended, the scorer shall make note of the exact situation at the time of the protest or suspension, including the score, the number of outs, the position of any runners, and the ball and strike count on the batter.

(4) The scorer shall not make any decision conflicting with the DYB Official Playing Rules or with an umpire's decision.

(5) The scorer shall not call the attention of the umpire or of any member of either team to the fact that a player is batting out of turn.

(6) The scorer is an official representative of the league.

10.01–(c) Credit the starting pitcher with a game won only if he has pitched at least three (3) complete innings and his team not only is in the lead when he is replaced but remains in the lead for the remainder of the game.

(d) Please refer to Rule 10.00 of the Official Playing Rules of professional baseball for detailed Official Scoring Rules.

## INDEX

Accidents to Player or Umpire: 5.10(c) & (h); 9.02 (d).

Appeals: 6.07(b), 7.10.

Balk:

Caused by Catcher: 4.03 (a);

Ball Dead: 8.05; No Penalty 8.05.

Ball:

When Called: 2.00—Ball; 6.02 (b); 6.08 (b); 8.04.

When Dead: 3.12; 5.02; 5.09; 5.10.

When Live: 3.12; 4.02; 5.01; 5.02; 5.11.

Balls:

Official Game: 1.09; 3.01 (c) (d) (e).

Defacing, Discoloring: 2.00—Illegal Pitch; 3.02; 8.02 (a).

Base Coaches:

Number of; Restrictions: 4.05.

Interference: 4.05; 7.09 (i-j); 5.08.

Accidental Interference: 5.08.

Batter:

Becomes Runner: 6.08; 6.09.

Interference by: 6.05 (h-i-k); 6.06 (c); 7.08 (g); 7.09.

Out: 6.02 (c); 6.05; 6.06; 6.07; 7.09; 7.11—Penalty.

Interference with: 6.08 (c).

Batter's Box: 2.00; 1.04; 6.03; 6.06 (b).

Batting Order: 4.01; 4.04; 6.01; 6.04.

Batting Out of Order: 6.07.

Catcher:

Interference by: 6.08 (c).

Interference with: 5.09 (b); 6.06 (c); 7.08 (g).

Position of: 4.03 (a).

Defacing, Discoloring Ball: 3.02 & 8.02 (a-5).

Definitions: (Alphabetically): Rules 2.00.

Deflected Batted Ball: 6.09 (f-g); 7.05 (a-f). Delay of Game: by Batter 6.02 (c); by

Pitcher 8.02 (b), 8.04; Forfeit for Delays 4.15. Discipline of Team Personnel: 3.02; 3.14;

4.05; 4.06; 4.07; 4.08; 4.15; 8.02 a (l); 8.02

(b-c); 9.01 (b-d); 9.05.

Equipment:

Ball 1.09; Bases 1.04, 1.06; Bats 1.10; Benches/Dugouts 1.08, 2.00—Bench;

Gloves 1.12, 1.13, 1.14, 1.15; Helmets 1.16, 1.17; Home Base 1.04, 1.05;

Pitcher's Plate/ Mound 1.04, 1.07; Shoes & Toe Plates 1.11 (g-h), 9.06;

Uniforms 1.11; Athletic Supporter/Cup 1.17; Chest Protector 1.17; Masks 1.17.

Equipment:

Observance of all rules governing 3.01 (a);

Not left lying on field 3.14; not basis for protest, but removed from game 4.19

(a), 1.10.

Thrown at Ball: 7.05 (a-c-e).

Fair Ball: 2.00—Fair Ball; bounces out of play 6.09 (f-g); 7.05 (f).

Fielder Falls in Dugout: 5.10 (f); 7.04 (c).

Fielder's Choice: 2.00—Fielder's Choice.

Forfeited Game: 2.00—Forfeited Game; 4.15; 4.16; 4.17; 4.18.

Ground Rules: 3.13; 9.04 (a-8).  
Illegal Pitch: 2.00; 8.01 (d); 8.02 a (6).  
Illegally Batted Ball: 2.00; 5.09 (d); 6.03; 6.06 (a).  
Infield Fly: 2.00; 6.05 (e) & (I)-Note; 7.08 (f)-Exception & Note.  
Injuries: 1:19, 3:03A Note2, 3:03D (2 i), 3:03D (1 & 2) Note 3, Local League Option #3  
(3, 4, 5)3:05A, 5:10C (1), 5:13 Note, Tournament Rule IX B (3 & 4) C (5 b)  
Intentionally Dropped Ball: 6.05 (1).  
Interference:  
    Defensive 2.00 (b); 6.08 (c);  
    Offensive 2.00 (a); 5.09 (f); 6.05 (h-i-k-m); 6.06 (c); 6.08 (d); 6.09 (b); 7.08 (b-f-g); 7.09; 7.11;  
    Spectator 2.00 (d); 3.16; 3.18.  
    Umpire 2.00 (c); 5.09 (b-f); 6.08 (d); 6.09 (b); 7.04 (b).  
Lights & Light Failure: 4.12; 4.14; 5.10 (b).  
Mandatory Play: Regulation IV (i).  
Missed Base: 7.02; 7.04-Note; 7.08 (k); 7.10 (b); 7.12.  
Obstruction: 2.00; 7.06.  
Official Scorer: 10.00.  
Overrunning First Base: 7.08 (c & j); 7.10 (c).  
Penalties: 2.00.  
Pitcher:  
    May not re-enter game as pitcher 3.03(a)(2).  
    Shall pitch to first batter 3.05.  
  
    Warming up 3.09.  
    Pitching in resumption of tie game 4.11 (e)-Note;  
    4.12. Legal positions 8.01 (a) (b).  
    Becomes Infielder 8.01 (e). Inning  
    Restrictions 8.07.  
    Throws to a base 7.05 (h); 8.01  
    (c). Throws at Batter 8.02 (c).  
    Preparatory Pitches 8.03. Visits  
    by Manager or Coach to:  
8.06. Player's Positions: 4.03.  
Playing Field: 1.04.  
    (Includes Diagrams of Mound, Diamond Layout and Playing Lines.)  
Postponement/Suspension Responsibilities: 3.10; 4.01.  
Protested Games: 4.19; 10.01 (b).  
Regulation Games: 4.10; 4.11.  
Resuming Play After Dead Ball: 5.11.  
Restrictions on Players: No fraternizing 3.09; Barred from Stands 3.09;  
    Confined to Bench 3.17.  
Runner:  
    Entitled to Base 7.01; 7.03;  
    Base touching requirements 7.02; 7.04-Note; 7.08 (d) (k); 7.10 (a), (b), (d); 7.12;  
    Advance of 7.04; 7.05; 7.06.  
    Reverse run prohibited 7.08 (i).  
    Is Out 5.08; 5.09 (f); 7.08; 7.09; 7.10; 7.11.  
    Running out of line 7.08 a (1).  
Score of Game: 4.09 (b); 4.11.

Scoring Rules: 10.00.

Scoring Runs: 4.09; 4.11; 5.02; 5.06; 5.10 (c); 6.09 (c) (g); 7.02; 7.05 (a); 7.12.

Spectators:

Barred from field 3.15; 3.18. Touching  
batted or thrown ball 3.16. Actions  
causing dispute 4.19 Note 1. Not  
mingling with 3.09.

Strike: 2.00—Strike; 2.00—Strike Zone.

Substitutions: 3.03; 3.04; 3.05; 3.06; 3.07; 3.08; 4.04; 4.08; 4.12; 5.10 (c).

Ten Run Rule 4.10 (a)(9).

Tie Games: 4.11.

Umpires: 9.01.

Unsportsmanlike Conduct: 4.06; 9.01 (d).

Wild Throws: 5.08; 7.05 (g-h-i).



# DYB REGULATIONS

## I. The League

(A) The League shall be the smallest unit of organization and shall be governed by those active in the local program which makes up the managing personnel, such as officers, executive committee, team managers, volunteer umpires, sponsors and player agent, serving as the volunteer operating personnel. The community aspect of the program should be the goal and be maintained.

(B) Each league or group of leagues shall operate within a single boundary, shall adopt a set of local rules and regulations for the operation of the league or leagues, and elect officers to manage the operations of the league(s). Local leagues may not adopt administrative rules and regulations which are in conflict with DYB Official Rules and Regulations.

**NOTE:** DYB\* recognizes that in communities where there are two or more franchised leagues, it may be advisable to have a common set of officers and adopt a single set of local rules and regulations. This is optional and shall be determined by the various leagues. DYB recommends that league officials who have financial responsibility with the league be covered by insurance.

(C) Leagues are assigned to districts within a state and are under the direction of a district director. All district directors and the state directors are under the direction of the National Commissioner.

(D) No district, state or national director or any designated tournament director shall have the authority to add, change, or waive any current rule or regulation, or to permit the violation of any rule or regulation.

(E)(1) Each franchised league shall be composed of a minimum of three (3) teams and not more than nine (9) teams in the Majors, "O"Zone, AAA and AA divisions; and not more than eleven (11) teams in the A division (6U & 4U).

(E)(2) Each league shall elect to participate in either the Majors or "O"Zone division for 12U teams by notifying the District and State Director on or before a date specified by the State Board of Directors.

(E)(3) Each league may be divided into as many as four (4) playing divisions: Majors or "O"Zone, AAA, AA and A for local league play. If the AAA, AA or A divisions has more than the maximum teams allowed in one league and is operating under a single franchise, the divisions with excess teams will be required to form another league with an equal (or almost equal) number of teams in each division in each league. An additional franchise number will be assigned to the additional league for the excess teams by the DYB Commissioner. **EXCEPTION**—The State Director may approve a two-team major league on a year-to-year basis.

(F) A franchised league shall be one which meets all qualifications of DYB and which is granted a certificate of franchise by the DYB Commissioner.

(G) All leagues having AAA, AA and A division teams shall be required to register all teams in each division with DY. **Exception:** With the approval of the State Director, DYB will accept a new league or leagues having only AAA, AA and/or A division teams.

(H) The annual franchise registration fee shall be \$14.00 per team per year for the Majors, "O"Zone, AAA divisions and AA division teams and \$8.00 per team per year for the A division teams. All leagues shall pay the same franchise registration fee, as stated herein, and no exceptions shall be granted.

(I) State registration fees, if any, shall be established by the state organization and shall be paid with the national franchise fees. The maximum state registration fee per league shall be \$50.00.

(J) A league's annual franchise renewal form and all franchise fees must be sent to the Commissioner's office on or before April 1. Franchise renewals postmarked after April 1 will result in a \$50.00 late penalty assessment which must be paid prior to the District Credentials meeting in order to participate in DYB sanctioned tournaments.

(K) Majors, "O"Zone, AAA, AA and A divisions are operated under the direction of a franchised league. Divisions are hereby construed to mean all activity in the following age divisions:

Majors/"O"Zone — League age twelve and under

AAA — League age ten and under

AA — League age eight and under

A — League age six and under

Exceptions to these age divisions may be made by league officials as they see fit during regular season play.

(L) Each state organization may adopt its own playing and tournament rules for A division and shall make these rules known to all leagues. However, the A division shall be subject to all the "REGULATIONS" in the "Regulations" section of this rulebook.

(M) With respect to the A division, all matters relating to both local league play and tournament play shall be under the exclusive supervision of the District Director unless otherwise provided for by the state organization.

## **II. League Boundaries**

(A) Each league shall submit an actual boundary from within which it will select its players for approval by the District and State Director. This boundary shall be marked on a map showing total population within the boundary and up-to-date copies of this map shall be on file with the State Director and District Director. New leagues establishing boundaries and old leagues altering their boundaries shall have the approval of the State Director and the District Director prior to such establishing of a new league's boundary or a change in the old league's boundary.

(B) If a league fails to submit a boundary map for approval, the state may establish a policy that sets the league boundary using the city limits, the local independent school district and/or other established boundaries as the league boundary.

(C) When two or more leagues operate within the same defined boundary, they shall be entitled to select players from the combined area IF THEY HAVE A COMMON SET OF LEAGUE OFFICERS AND FOLLOW THE SUPERVISION OF ONE PLAYER AGENT IN PLAYER SELECTION. All managers MUST have equal opportunity in the selection of players and the player selection system must create an equal distribution of players of each LEAGUE AGE in each league. A multi-league organization, sharing a common boundary, with the written approval of the state director can redraft the entire program annually for the specific purpose of balancing numbers

and/or talent between the leagues within the common boundary. The state director may require the DYB District Director or other designated DYB official to monitor the redraft which must be conducted by only one player agent and strictly follow the provisions of Regulation II(D). In a multi-league boundary, players may be redrafted into other leagues within the boundary at this time or at such time as a redraft of the league occurs to place players advancing to a new age division on teams.

(D) Two or more leagues operating under separate boards may operate within the same boundary or an overlapping boundary area shown on their boundary maps by written agreement of the leagues concerned and approved by the State Director.

(E) Small Towns or Communities - Small nearby towns or communities unable to field a league within their own area shall be permitted to form three (3), four (4), five (5), six (6) or seven (7) teams with each town or community forming teams without a common draft with the other small towns or communities in the league.

(F) No new league shall be franchised in the territory of an existing league or leagues without the written approval of the existing league or leagues. Organizations franchised with DYB the previous year shall always have first refusal of franchising in succeeding years except as noted below: EXCEPTION:

Under certain circumstances, the renewal of a franchise may be denied if it is the opinion of a two-thirds majority of (1) the State Director, (2) all members of the Board of Directors of DYB from the state, and (3) the District Director of the district in which the league plays, that it is for the best interest of DYB within the particular state that the existing organization not be franchised for the current year and they each sign a statement to this effect setting out the reasons therefore and provided that team membership shall not form a basis for not franchising. In case the DYB Commissioner does not approve the disfranchising of the league, the President of DYB shall appoint a committee to investigate the matter and make a final decision.

**EXCEPTION:** In the case of a request for a new league which is located in an area already claimed by a franchised league but the existing league has made no effort to provide a program for the new group, the State Director with the approval of the District Director and the National Directors in that state, may allow the new league to be franchised. (**Note:** This will only apply in cases where an existing league is obviously preventing a new league from entering DYB.)

(G) League boundary maps showing total population figures shall be on file with the State Director and District Director prior to the playing of the first game on the schedule. An updated copy of this map with new population figures is to be provided to each of these officials with franchise renewal forms each tenth year beginning in 2002 or at any time the boundaries may be changed. Boundaries for any new league or alterations to existing boundaries must be approved by the District Director and the State Director.

(H) The Board of Directors of DYB allows each league and players accepted by a league to continue playing in the league, any player:

- (1) whose residence changes after he becomes a member of the league, and/or;
- (2) who lives outside of the league's boundaries because of a revision of such boundaries, even though now residing in the territorial boundaries of another league.

**NOTE: A player must elect to remain in league or join the new league in which boundary he now lives in the year of change. Once an election is made, he must remain in the chosen league until he reaches league age 13. Exception IV(E) or IV(F).**

(I) Players who are members of a league or leagues within a defined boundary, including players acquired under Regulations IV(D), IV(F) and IV(G) shall remain the property of the league unless they move to a new permanent address within the boundary of another DYB league(s); or, unless otherwise provided for in these rules.

(J) Players who are members of a specific league within an organization with multiple leagues which share a common boundary must remain only in this specific league until such time as ALL PLAYERS of his league age are redrafted pursuant to Regulation II(C) or IV(H). **PENALTY:** Player(s) who violate this rule will be ineligible for tournament play.

(K) (1) **INELIGIBLE PLAYER** is a player who is ineligible to be a member of a tournament team for a league because he does not live within the approved boundary of the league, a player who did not meet the participation requirements in his/her league, or a player who is older than the maximum league age allowed for the respective age division of play. Example: A league age 12 player shall not play on a league age 10 and under division tournament team.

(2) Any player that registers and plays in any DYB league shall be ineligible to participate as a member of the league's tournament team if he does not reside within the league's approved boundary under any circumstance except as provided in Regulation IV(D), IV(E) or IV(F). Any such player shall be designated as an "ineligible player" for tournament eligibility purposes. No waivers or releases are allowed for any reason other than as provided in Regulation IV(D). The parent or guardian of the player shall be responsible for determining if his/her child is eligible to participate on any of the league tournament teams under DYB Rules and Regulations.

(3) Any league that registers and allows a player who does not reside within its approved boundary or does not meet the requirements of Regulation IV(E) or IV(F) to participate in its league shall not allow such player to participate as a member of the league's tournament team under any circumstance except as provided in Regulation IV(D). Any such player shall be designated as an "ineligible player" for tournament eligibility purposes. No waivers or releases are allowed for any reason other than as provided in Regulation IV(D). All league officials including coaches and volunteers in a league shall be responsible for determining if a player is eligible to participate on any of the league tournament teams under DYB Rules and Regulations.

**PENALTY:** The player shall be ineligible to participate on any of the league's tournament teams. If the league places an ineligible player on a league tournament team roster, the player shall be subject to disqualification and removal from the team upon protest, prior to the conclusion of the player's first tournament game. See Tournament Rule XII (H)(2).

(L) The state Board of Directors has exclusive authority to determine the proper boundary for eligibility purposes for any player whose parents claim to own or rent dual residences located in more than one league boundary.

(M) (1) With the written approval of the State and District Director a league may extend their boundary to include players that do not currently reside within the boundary of a league franchised by DYB. This area to be included must be contiguous to the current boundary of that league.

(2) With the written approval of the State and District Director a group of leagues may extend their boundaries to include areas contiguous to the group of leagues that do not currently have a franchised DYB league. Such an area will become



a common boundary for that group of leagues. Players from the common boundary may register with any of the contiguous leagues. Once such a player registers and is accepted by a league, that player shall remain the property of that league unless otherwise provided for in these rules.

### **III. Teams**

(A) Each team may consist of a maximum of 15 uniformed players whose names shall be registered with the League President not later than five days prior to the first regularly scheduled game of the league season. Team membership shall be within the sole discretion of each league, provided such membership shall not be in conflict with the Constitution and By-Laws and the Official Rules and Regulations of DYB.

(B) **League age is that age attained by a player prior to May 1 of the current season.**

(C) Local league officials shall adopt their own rules in regard to the replacement of players on team rosters. **NOTE:** League officials shall not allow managers to drop players from their rosters without cause regardless of the playing ability of the player. Reasons for the replacement of players shall include moving out of a community, sickness or injury, disciplinary measures, failure of the player to attend practice or games, and safety precautions. The reason for replacement of players shall be included in a written statement by the team manager filed with league officials.

### **IV. Selection of Players**

(A) Each league shall determine its own method for the selection of players for team rosters. However, any player selection system used shall be in the form of a draft system, a talent distribution system, or an auction system and shall be under the direction of a player agent who shall see that all teams have an equal opportunity in the selection of all players. DYB recommends that much care be taken in the selection of the individual to fill the position of player agent. Leagues should also be encouraged to charge an assigned draft pick when children of managers or assistant coaches do not go through a player selection system.

(B) The DYB Commissioner shall furnish suggested player selection systems upon request by the leagues.

(C) Players who do not register in time to participate in the player selection system shall be ineligible, with these exceptions:

(1) any who were sick or injured during registration period and confirmed by a physician's written statement; or

(2) any who became new permanent residents of the community after the registration period. A new resident arriving after the selection may be assigned to a team provided all managers of teams participating in the player pool and the league president approve the assignment in writing.

(3) **Local League Option:** A player may be signed up after the local league drafts are completed prior to or on the first game day of a league's regular season provided the regular season team(s) with the least number of players on its roster(s) will be eligible to draw for the right to select the player.

(D) **Player Releases** — The League President where a player legally resides may request a release by submitting an application for the player's release. The deadline for submitting an application shall be by April 1st or before the first league game of the

releasing league, whichever date is earlier. The application will be submitted to the State Director and State Board of Directors and acted upon by the State Board of Directors within 10 days of State Director's receipt of the application.

(E) Managers shall not drop a player from their rosters in order to sign a new player. **PENALTY:** The penalty for violation of this regulation shall be loss of tournament eligibility for the player illegally picked up and grounds for protest in local league.

(F) Any player to whom the courts have appointed a custodial parent or guardian may play local league and be eligible for tournament play for a league in either the boundary of the custodial parent or the boundary of the non-custodial parent without a release.

(G) Any player may play local league and be eligible for tournament play for a league in either the boundary where he resides or the boundary of the league where he attends public or private school (excluding home schools) with the exception that he/she can only transfer from school to school one (1) time and cannot go back and forth.

(H) Two or more leagues operating within the same defined boundaries which select players using a single player agent must put all returning players from all teams in any dropped league into a common draft where all managers in the remaining league(s) have an equal opportunity in the selection of players.

#### **V. Player/Coach Eligibility and Registration**

(A) All leagues shall file a roster of players, managers and coaches of each team in the league with the State and District Director on or before May 1.

(B) The online roster form shall include the name of the player, his date of birth and his residence in detail. **NOTE:** Should there be changes to these rosters the District and State Directors must be notified in writing of the change.

(C) A maximum of three managers/coaches may be registered on each Majors, "O" Zone or AAA team. A maximum of four managers/coaches may be registered on each AA or A division team. Only those managers/coaches so registered shall be eligible to coach tournament teams.

(D) An eligible player shall become subject to DYB Rules and Regulations when he/she registers with the league for the current year.

(E) Each league shall determine its own method for selection of managers and coaches. All managers and coaches shall be adults of at least 18 years of age.

(F) Local leagues have the authority to establish league rules to suspend managers and coaches for unsportsmanlike acts or willful violation of local rules and regulations as well as rules and regulations established by DYB.

#### **VI. Player Age Limit and Birth Certificate**

(A) Anyone whose thirteenth birthday falls on or after May 1 of the current calendar year shall be eligible to compete in regular season and tournament play during the current DYB season.

(B) Dates of birth of players shall be certified by birth or baptismal certificate, U.S. passport or other legally accepted proof of age to a designated league official prior to the league's first scheduled game. Each league president is responsible to ensure that no player is over league age and that records of proof of age are available upon request. One of the following documents shall be used to verify age:

(1) Birth certificate issued by a government agency which has a raised or affixed seal and is accepted as legal proof of age.

(2) Hospital certificate issued at birth.

(3) Baptismal certificate issued within first six years after birth which shows actual date of birth. **NOTE:** A photo static copy of one of the above certificates, which has a statement on the document stating that it is an exact and true copy of the original, signed by the parent or legal guardian shall be accepted.

(4) Unexpired passport issued by the U.S. Government.

(C) The local league shall have the authority to determine the age limits within the league's Major or "O"Zone, AAA, AA and A divisions during regular season play. Any player of league age ten and under who was registered on a major league or "O"Zone team during the regular season shall be eligible to participate in the appropriate AAA, AA and A division (age ten and under) tournaments. A player can participate on only one tournament team. See Tournament Rule IV(B) for age restrictions in tournament play.

## **VII. Pitching Requirements (Regular Season Only) See Rule 8.07**

## **VIII. Regular Season Schedule**

(A) Each major and AAA team shall play a regular schedule of not less than fifteen (15) games nor more than twenty-five (25) games, exclusive of championship games. The number of AA and A division league games shall be determined by the local league.

(B) Two or more leagues shall be permitted to play an interlocking schedule of games, but all such games shall count in the won and lost column of each league.

(C) Exhibition games shall be permitted but all pitching rules shall be followed. Permission for exhibition games must be secured from the league president or his delegated authority.

(D) It is recommended that each team play a schedule of two games per week.

(E) Any game played before the league's franchise is renewed shall not be considered as an official game and cannot be counted in the minimum number of games required to qualify for tournament participation.

(F) CHAMPIONSHIP GAMES are playoff games played by two or more teams tied at the end of regular season play with identical won/loss records to determine a league champion; or when applicable, first or second half winners to determine a league champion or playoff games between tied teams to determine first or second half winner. These are not scheduled regular season games, but additional games required to determine a league champion or first or second half winner. They are not to be considered as tournament games and are to be played according to regular season rules with the exceptions provided in Rule 8.07 (f), (g), (h).

## **IX. Team Sponsors**

(A) No firm or company who's advertising primarily reflects the sale or use of alcoholic beverages or tobacco products (including e-cigarettes) shall be permitted as a sponsor of the DYB program, either locally or nationally, and shall not be permitted to display any form of such advertising in connection with the program.

## **X. Admission to Games**

(A) Tournament hosts may charge reasonable admission to tournament games at all levels of tournament play by through the DYB World Series. Proceeds shall be used to defray expenses of the tournament.

## **XI. Other Youth League Participation**

(A) No league franchised with DYB shall franchise its teams with any other youth baseball program. PENALTY: The penalty for violation of this rule will be revocation of the league's DYB franchise.

(B) WITH THE APPROVAL OF THE LOCAL LEAGUE, players, managers and coaches may participate in other youth baseball programs during the DYB regular season provided such participation does not disrupt DYB regular season play.

**NOTE:** Leagues may remove any player, manager or coach from a team for the current season for repeatedly missing regular season games and/or practices.

## **XII. Conduct and Sportsmanship**

(A) Members of a team shall not ride, kid, heckle, poke fun at or in any other manner do anything that in the opinion of the umpire distracts the opposing team. A player shall not throw a bat, helmet or other equipment in anger or disgust. The penalty for violation of this rule shall be the removal of the guilty player from the game for the remainder of the game. The penalty for violation of this rule by a manager or coach shall be his removal from the game and the dugout for the remainder of the game.

(B) Local leagues have the authority to ban noisemakers during local league play.

(C) When a batter wiggles the bat in an EXTREME MANNER in which, in the umpire's opinion, the batter is intentionally attempting to distract the pitcher's delivery of the pitch to the batter, this action shall be deemed unsportsmanlike conduct and not permitted. The umpire shall call a no pitch and meet with the batter and manager to give a warning upon its first occurrence. Upon a second occurrence, the team manager shall be cited for unsportsmanlike conduct and removed for the remainder of the game.

(D) The fake bunt/hit away tactic will not be allowed. Aggressive defensive play brings the players too close to the batter in an attempt to take the bunt away from the batter completely, which becomes a safety concern. Once a batter squares to bunt, he may:

- (1) Pull the bat back and take the pitch or,
- (2) Attempt to bunt the ball.

The batter may not swing away after squaring off in the bunt position and drawing a fielder dangerously close to the batter's box. The umpire shall call no pitch and meet with the team and team manager to give a team warning upon the first occurrence. A second occurrence will result in the removal of the team manager for the remainder of the game.

(E) The use of any alcoholic beverage or tobacco product (including e-cigarettes) within the confines of the playing field, dugout or bench by any manager, coach, player, umpire or league official is prohibited. The penalty for violation of this rule shall be the removal of the guilty manager, coach, player, umpire or official from the game and from the dugout.

(F) Local leagues have the authority, as permitted by local and state law, to remove or ban from the league's playing facilities any spectator who is flagrantly displaying unsportsmanlike conduct, profanity, or who threatens physical harm to umpires, players, managers, coaches or league officials. This authority extends to all scheduled regular season games or tournament games played at its playing facilities.

### **XIII. DYB Child Protection Plan (A child abuse/molestation risk management plan)**

Congress enacted a new Federal law (Public Law 115-126) in 2018 which establishes a nationwide standard “duty to report” suspected child abuse. The “Protecting Young Victims from Sexual Abuse and Safe Sport Authorization Act of 2017” (“Safe Sport Act”) mandates that all amateur sports organizations, which participate in an interstate or international amateur athletic competition and whose membership includes any adult who is in regular contact with an amateur athlete who is a minor must report suspected child abuse, including sexual abuse, within 24 hours to law enforcement.

The Safe Sport Act subjects all DYB franchised leagues to the provisions of this federal law because each league has adults working with youth who are in repetitive contact with minor athletes.

(A) Child abuse/molestation can take many forms including verbal abuse, physical abuse, emotional abuse, and sexual abuse. Any form of child abuse/molestation is contemptible and goes against the policies and mission of DYB.

(B) DYB is committed to addressing concerns over child abuse/molestation by informing and educating its affiliated leagues on this risk by providing the DYB Child Protection Plan (a child abuse/molestation risk management plan) for adoption by all DYB leagues. This plan may significantly lessen but not totally eliminate the chance of an occurrence. Failure to implement the DYB Child Protection Plan or a similar comprehensive plan may expose leagues and its officials, volunteers and other representatives to significant legal liability.

(C) DYB requires that all franchised leagues adopt and implement the DYB Child Protection Plan or a similar comprehensive child abuse/molestation risk management plan. The league may download the DYB Child Protection Plan from the DYB website at [DYBUSA.org](http://DYBUSA.org) for adoption by the league or its sponsoring organization.

(D) DYB has no operational control over league security including the selection of volunteers associated with independent leagues which affiliate with its program. Therefore, it is the sole responsibility of the independent leagues to act by adopting and implementing the DYB Child Protection Plan or a similar comprehensive child abuse/molestation risk management plan.

(E) Any plan adopted by a league and/or its sponsoring organization must include a provision for conducting criminal background checks which searches the National Criminal Database and the National Sex Offender Registry in all 50 states (not limited to just sexual offender records) from state and county databases on all managers, coaches and other authorized adult participants in the league who have repetitive access to and close contact with minor athletes.

(F) Due to the fact DYB has no operational control over league security including the selection of local league volunteers, each franchised league shall be required to indemnify and hold harmless DYB against all legal actions based on child abuse/molestation allegations arising from any team, league, tournament or other activities of such league.

# DYB TOURNAMENT RULES

## (TOURNAMENT PLAY ONLY)

**No National, State or District Director or any appointed assistant directors shall be permitted to waive any DYB tournament rule.**

### **I. Tournament Play**

(A) A **SANCTIONED TOURNAMENT** is any level of tournament play approved by DYB (including a two- out-of- three series) which allows each franchised league to enter two teams in the Major or “O”Zone, AAA, AA, and A divisions at the first level of tournament play to compete for the right to advance to subsequent levels of sanctioned play. Each league is entitled to enter, and no play-off to enter may be required. **NOTE:** Any non-sanctioned tournaments supervised by DYB officials must be approved by the respective DYB state organization. **STATE OPTION:** In 12U divisions, one team each may play in “O” Zone and Majors tournament play.

(B) (1) Each state organization may use only double elimination tournament brackets and three, four, five, or six team pool play tournament formats approved by the Commissioner to advance teams to the next level of tournament play. States may advance more than one team to the next level of play.

(2) “Double elimination” is defined as when a team loses two games in a single tournament using double-elimination brackets at any level, area, sub-district, district, state or World Series, and is eliminated from further participation in that tournament.

(3) “Pool Play” is defined as a round-robin tournament where teams in a designated pool or pools play each other once. The pool play winner shall be the team with the best won-lost record at the completion of pool play. Round-robin tournaments will be played to completion.

(4) Each state organization may advance more than one team from all levels of tournament play to the state tournament. and distribute these procedures in writing to all leagues and DYB officials within the state.

(5)(a) **Two Runners-Up** - If three teams remain with one loss and all have played the same number of games in double elimination brackets approved by the Commissioner, there will be two runners-up in the tournament.

(b) **Advancing More Than One Team from Tournament Bracket** - Any two tied teams with the same won-loss record after completion of a double elimination bracket must play a one game playoff to determine which team advances where more than one team advances to the next level of tournament play. **EXCEPTION:** The head-to-head tie-breaker rules may be used in lieu of a playoff game if the teams have played each other during the tournament. No other tie-breakers may be used in double elimination tournaments.

(6) The tie-breaker rules listed below will be used in all round-robin tournaments to advance a runner-up team or teams in addition to the champion to the next level of tournament play.

### **TIE-BREAKER RULES**

Rule 1. Head-to-Head Record Between Tied Teams

Rule 2. Least Runs Allowed Between Tied Teams

Rule 3. Least Runs Allowed for All Games

Rule 4. Most Runs Scored for All Games

Rule 5. Coin Flip

**State Option:** The state organization may elect to not use the playoff schedules in the round robin pool play formats and may determine the order of finish strictly by tie-breakers. **EXCEPTION:** If three or more teams are tied with the same won-lost record, apply each tie-breaker rule in order until you break out a team; then, apply each tie-breaker rule in order for the remaining teams until you break out a second team, and so on until all ties are broken.

(7) The state organization may authorize a one game playoff between two teams advancing from separate double-elimination brackets or round-robin tournaments; or, the state organization may use a two-out-of-three Series format.

(8) In double elimination tournaments, two-out-of-three, three-out-of-five or one game playoffs with teams advancing from double elimination or pool play round robin play shall be considered a new level of play for pitching restrictions but all rest requirements for all pitchers shall remain in effect.

(C) All official playing rules and regulations used during regular season play shall be in effect during sanctioned tournament play unless otherwise stated in the tournament rules below.

(D) A Division (T-Ball) tournaments shall be under the exclusive direction of the District Director or his designated representative at the district level.

(E) Appeals are only accepted through DYB channels for the sanctioned tournaments. Appeals in non-sanctioned tournaments must be handled through the organization sponsoring the tournament.

(F) Each community or league sponsoring a state tournament or a Division I or Division II DYB World Series shall be granted a host team. **Exception:** A Division I league which hosts a Division II World Series must designate a Division II league within its state as the host team. **NOTE:** A host team shall be allowed only in the event there is a tournament, not a series between two teams.

(G) A host city having two or more leagues shall be entitled to hold a playoff to determine the host team, and the other leagues shall be entitled to enter district eliminations.

(H) All tournament hosts shall be determined using guidelines established by the state organization.

(I) Host teams shall not participate in any tournament in any level of tournament play below that in which they act as host. As a matter of interpretation, however, a host is not a host until selected. The penalty for violation of this rule is loss of eligibility for tournament play.

(J) Any tournament team wishing to compete only through the district or state tournament shall be permitted to do so provided the State Director is notified prior to July 1. In the event, such a team wins the district or state tournament, the runner-up team shall be declared the representative to the next tournament level.

(K) The Division I and Division II DYB World Series (Majors, "O"Zone, AAA and AA) shall be limited to a maximum of twelve teams of which one shall be the host team and a maximum of eleven state champions. All teams will be winners/qualifiers of state/regional Division I and Division II competitive play. Any qualifying teams which decline to participate shall be replaced with winners of competitive play as determined by the Commissioner.

(L) To participate in the DYB Division I or II Majors World Series a state must offer state tournament play in the Majors division. The DYB Division I and II Majors World Series may consist of the winner and runner-up from each state that plays a Majors state tournament plus a host team. The Commissioner will take any action(s) needed to ensure that the DYB Division I Majors World Series has a minimum of eight (8) teams participating in the tournament. The Commissioner will take any action(s) needed to ensure that the DYB Division II Majors World Series has a minimum of six (6) teams participating in the tournament.

(M) Each state organization shall approve the Division I and Division II status of each franchised league and/or adjust a league's Division I or II status within its state pursuant to guidelines established by the National Board of Directors.

(N) All state and sectional tournament sites shall be selected on or before June 1 of the current year. In the event a state tournament site is not determined by this date, the State Director with State Board approval, shall have the authority to request bids and award the tournament. In the event a sectional tournament site is not determined by this date; the Commissioner shall have the authority to request bids and award the tournament bid.

### **Tournament Dates**

(O) The Division I and Division II DYB World Series for the Majors, "O" Zone, AAA and AA divisions shall begin on the dates recommended by the Executive Committee and approved by the National Board of Directors, annually. These dates will be set five years in advance.

(P) All tournaments qualifying a team for the Division I and Division II Majors, "O" Zone, AAA or AA World Series shall be scheduled to be completed no later than ten calendar days prior to the day of the opening ceremonies of the respective World Series. The penalty for violation of this rule is disqualification of the winning state/regional team from the DYB World Series.

(Q) The earliest date a sanctioned DYB tournament may be scheduled to begin shall be determined by each state organization.

## **II. Financial Responsibility**

(A) All teams entering tournament play must be financially able to defray all their travel expenses.

(B) The host city shall file a financial statement of any DYB World Series with the Commissioner following the completion of the event.

(C) **Tournament Admission Fees** – Each district, state and World Series Host shall collect an additional \$1 for each game day pass sold for the first two days and an additional \$1 for each tournament pass sold which will be donated by the Host to the DYB Scholarship Fund. The admission fees for the tournament pass and game day pass must be approved by the District Director, State Director, or Commissioner.

(D) **Tournament Host Insurance & Team Insurance for Sanctioned Tournaments** Tournament hosts must present required insurance coverage to the District Director, State Director or Commissioner, as applicable. Tournament teams must present required insurance coverage to the tournament credentials committee(s). Hosts and all teams participating in sanctioned and other approved DYB tournament play must provide evidence of insurance coverage which meets the following requirements:

(1) **Excess Accident** – The Tournament Host and each tournament team must be covered by an Excess Accident policy under their respective organizations' names with a medical limit



of at least \$50,000. For teams, it is not acceptable for each parent to provide individual evidence of health insurance for his or her child. For the tournament host, coverage must be provided for all umpires, scorekeepers, employees and volunteers; and,

(2) **General Liability** – The Tournament Host and each tournament team must be covered by a General Liability policy under their respective organizations' names with an "each occurrence" limit of at least \$1,000,000 combined single limits for "bodily injury" and "property damage". Such policy may not provide "claims made" coverage and may not have exclusion for lawsuits arising out of injuries to athletic participants. If the tournament host or team does not purchase its General Liability insurance through the approved DYB. insurance program, it is required that the General Liability policy name DYB. as an "additional insured".

### III. Team Eligibility Requirements

(A) Each league shall be entitled to enter either its local league champion or a team chosen from the entire league as its tournament team in each age division.

(B) Division I tournament team affidavits must consist of twelve (12) players, a team manager and the required number of coaches. Each tournament team must begin each level of tournament play with a full roster of players and coaches. **Alternates are not recognized as part of a tournament team. NOTE:** Non-sanctioned tournaments not supervised by DYB District, State or National officials cannot use the DYB Tournament Team Eligibility Affidavit to qualify teams.

(C) All Division II tournament teams must consist of 11 players, a manager and the required number of coaches on a tournament team.

(D) All tournament teams participating in the Majors, "O"Zone, AAA, or AA state tournaments shall be required to deliver an acceptable digital group photo image of the team in uniform (including the team manager and only the required number of coaches)

(E) Each tournament team is required to have twelve (12) players (**eleven (11) players on Division II tournament teams**) a manager and the required number of coaches present at each tournament game except that any unfilled player vacancy or a player's absence may be approved by the tournament director for justifiable reasons except for participation in other tournaments or family vacations which are covered under Tournament Rule IV(C). The tournament director may suspend a team manager from participating in any game where a player vacancy or absence cannot be justified. The tournament director may require a team to replace a player whose continued participation on the team is in doubt.

(F) Participating teams shall completely and accurately complete by the deadline all forms furnished them. Teams failing to comply with this rule may not be eligible for tournament participation and may lose their next opportunity to host a tournament.

### IV. Player/Coach Eligibility Requirements

(A) Only players who have played in a minimum of eleven (11) of their local league games shall be eligible for tournament competition, with the exception that the state director shall be empowered to rule a player eligible, for good reason, even though the player has not played in eleven (11) games. DYB urges state directors to grant this exception only for good and substantial reasons, such as injury or sickness by the player substantiated by a physician's notarized statement, weather conditions causing postponement of games, and instances in which leagues were late in starting its seasons and therefore unable to complete a majority of

its games prior to the start of tournament play. There may be other reasons for granting an exception, and the state director shall exercise discretion.

(B) All players on a major tournament team may be league age 12, if desired. The maximum age for players on minor league tournament teams shall be league age ten (10) for AAA division, eight (8) for AA division and six (6) for A division. Any player of league age ten (10) and under who was registered on a major league team during the regular season shall be eligible to participate on the AAA (9-10) tournament team. LOCAL LEAGUE OPTION: A league may require that any player of league age ten (10) and under must be registered on a minor league team during the regular season to be eligible to participate 10U tournaments..

(C)(1) A player, a coach or a team may participate or play in another tournament between scheduled DYB tournaments. However, a player, or replacement player, coach or a team shall not participate in any other tournament during a sanctioned DYB tournament including any days their team is not scheduled to play during the DYB tournament. **PENALTY:** Any player, or replacement player, manager or coach who violates this rule shall be removed from their DYB tournament team roster immediately. Any team who violates this rule shall be disqualified from tournament play immediately.

(2) A player, replacement player, manager or coach shall not miss the first game of each level of DYB tournament play due to travel delays from participation in another tournament or travel delays from a family vacation. **PENALTY:** Any player, or replacement player, manager or coach who violates this rule shall be suspended for the second game of the tournament and the player shall be ineligible to pitch in this level of play but may pitch in the next level of play if his team advances.

(3) A team shall not miss the first game of each level of DYB tournament play due to participation in another tournament for any reason. **PENALTY:** Any team who violates this rule shall be disqualified from tournament play immediately.

(D) No manager or coach shall participate on more than one DYB sanctioned tournament team at the same time.

(E)(1) No player shall participate on more than one of a League's DYB sanctioned tournament teams at the same time.

(E)(2) Under no circumstances can a player be listed on the original tournament roster affidavit of more than one of a league's DYB tournament teams during the same year.

**Exception:** Players who are rostered under a specific league franchise number who participate on non-sanctioned rosters or the rosters of second sanctioned teams within a playing division may be used as replacement players with the approval of the state director if their original tournament team has been eliminated from competition.

(F) Only managers, assistant managers or coaches during the regular league season shall be eligible to manage or coach a tournament team, and they shall be registered on their regular season team player rosters as filed with the district and state directors. The state director shall be empowered to grant exceptions to this rule.

**(G) No DYB official, elected or appointed, shall serve as a tournament director or any other official capacity in tournaments in which he/she manages or coaches in any tournament in which his team participates including any time after his/her team is eliminated from the tournament. Exception: No National Board member, elected or appointed, shall be eligible to manage or coach a tournament team under any circumstances.**

(H) Upon the recommendation of the Tournament Director, the State Director shall have

the authority to suspend from tournament play any player, manager or coach for a flagrant display of unsportsmanlike conduct or for a willful violation of DYB Rules and Regulations. A player, manager or coach who is suspended shall not be allowed to participate in further tournament play in any way

to include opening or closing ceremonies and trophy presentations. The suspension may be for one or more games or for the remainder of tournament play during the current season. The DYB Commissioner shall have this authority during the DYB World Series.

(I) After an investigation conducted by the DYB Commissioner's Office, the National Board of Directors of DYB by a majority vote shall have the authority to suspend a player, manager or coach for the next season or impose a lifetime ban to the individual from participation in DYB tournaments.

(J) The State Board of Directors may adopt policies and guidelines to ban managers or coaches from tournament play for one or more years. This decision may be appealed to the Commissioner's Office.

#### **V. Tournament Team Roster Affidavit**

(A) The tournament team roster affidavit shall be completed by the league online for each tournament team and printed in triplicate. The league shall deliver three signed originals of the team roster affidavit to the District Director at the District Credentials Meeting prior to the first tournament game. Each tournament team manager shall keep one of the originals of the tournament team roster/affidavit, properly completed, to present at all tournament games.

(B) The league president shall confirm that the players' names on the tournament affidavit are listed exactly the same as appears on their birth records.

(C) –**Tournament Director**– With respect to sub district, district and state tournaments, district and state directors may delegate their authority to a designated tournament director. The National Commissioner shall designate a tournament director for the DYB AAA World Series and may designate a tournament director for the DYB World Series in his absence.

(D) –**Credentials Committee**– In addition to the tournament team roster affidavit each team manager shall have a birth record and medical release form for each player whose name appears on the affidavit. The affidavit, medical release form and the birth records shall be publicly inspected and approved by a credentials committee composed of three members, one of whom may be the tournament director, and this public inspection shall be at least one week (seven days) prior to the first sub district or district game. All teams shall be notified of the credentials meeting by the district director or the tournament director at least one week prior to the inspection. This requirement shall be for sub-district and district play only.

(E) Teams failing to be present at the district credentials meeting with the team roster affidavit, birth records and medical release form shall forfeit their right to compete in tournament play. Teams shall have a birth record and medical release form at this meeting for each player listed on the player affidavit. In the event a team does not have a birth record for a player at this meeting, the player for whom there is no birth record shall be ineligible to play in the sub-district or district tournament.

(F) The state or district director shall be empowered, however, to make exceptions to the seven-day inspection rule for hardship cases. A player whose birth record is not accepted by the credentials committee at the inspection meeting shall have the opportunity of submitting

another birth record to the committee on the evening prior to the first tournament game at a time and place set by the tournament director. Player affidavits may be corrected for spelling, typographical errors, nicknames and so on at either of the two meetings of the credentials committee. Players whose birth records are not accepted by the credentials committee at either of the two meetings shall be ineligible for all games in the sub-district and district tournaments. There shall be no appeal. **Team Disqualification - A team using a player not approved by the credentials committee shall be disqualified from tournament play.**

(G) Where separate district credentials meetings are held for each division's sub-district tournament, the credentials committee shall inspect the player affidavits and birth records of all the tournament teams in the respective division at the same time. There shall be a credentials meeting for each division in the district. All credentials meetings within a district may be held at the same time.

(H) The state director or tournament director shall set the date and time for the inspection of the team roster affidavits and birth records for teams competing in state tournaments, and this time shall be at least three hours prior to the first game of the tournament. Teams not complying with this rule shall be subject to disqualification.

(I) With the exception of the host team, the actual birth certificates may not be inspected at the DYB World Series. Instead, each state director may sign the player affidavit of his state's representative team in the DYB World Series signifying that he or his representative has personally inspected the birth records of the players and found them to be in order. The player affidavit and birth records of the host team shall be inspected by the National Board of Directors. No protest shall be allowed at the DYB World Series on the basis of eligibility because of age unless the protest is substantiated by actual evidence accepted by the Board of Directors as proof of an age violation.

(J) DYB directs all tournament directors and credentials committee members to accept one of the following as proof of age:

(1) Birth certificate issued by a government agency which has a raised or affixed seal and is accepted as legal proof of age.

(2) Hospital certificate issued at birth.

(3) Baptismal certificate issued within six years after birth which shows actual date of birth. NOTE: A photo static copy of one of the above certificates, with a statement on the document signed by the parent or legal guardian stating it is an exact and true copy of the original. DYB Certification of Birth Record properly completed, inspected, signed, and stamped by a DYB district, state or national director or the Commissioner.

(K) Adopted children going by a name other than that which appears on the birth record shall furnish an affidavit of the adoption or name change and a copy of the affidavit shall be attached to the birth record. Players not legally adopted but using a name other than that which appears on the birth record shall be eligible provided a notarized statement of this fact is made before a probate judge or clerk of court or their equivalent and the statement is attached to the birth record with the signature and seal of clerk of court.

(L) A Protest of eligibility based on age may be presented to the tournament director at any time during tournament play. No protest of an age violation shall be allowed after the inspection by the credentials committee without absolute proof of fraud. The burden of proof shall be upon the protesting party. In the event proof of fraud is found and accepted by the credentials committee or a tournament director, Rule XI,(H)

(3) will apply.

(M) Players who are unable to furnish an approved birth record shall be entitled to mail other documents of proof of age to the Commissioner, who shall be empowered to issue a certificate in lieu of an actual birth record.

**Replacing Players** (A) A team may replace tournament players after their selection to the team following investigation and approval by the District Director at District level, State Director at State level or Commissioner at the World Series. The new player must present proper proof of age and be otherwise eligible according to rules and regulations of this program including the restrictions in Regulation IV(C). The player who is replaced shall not be entitled to return to the team unless he was a replaced injured player and he replaces another injured player. A replacement certificate shall be available from the District or State Director or Commissioner. Requests for replacements shall be made in writing by the local league President to the District Director at district tournaments, State Director at the state tournament or Commissioner at the World Series.

## **VI. Tournament Pitching Rules**

These tournament pitching rules completely replace the pitching restrictions used in regular season play. Protecting youth pitcher's arms is extremely important and the following pitching restrictions and mandatory pitcher rest requirements are designed to minimize or prevent serious arm injuries to youth players.

### **Pitcher Substitutions/Restrictions**

(A) All players on the tournament team roster may pitch in any tournament (bracket or pool play) game.

(B) All pitchers shall be eligible at the beginning of each level of tournament play provided they have had the required number of hours of rest as noted below since their last tournament game in the previous tournament.

(C) Pitchers shall be governed by the substitution provisions of Rule 3.03(c), Rule 3.05(a) & (b) and Rule 3.08(1) during tournament play. A pitcher may not return to the mound as a pitcher during the same game. **EXCEPTION:** A pitcher who is replaced in the batting order by a substitute runner or substitute batter may return to the mound to pitch provided no other pitcher on the same team has thrown a pitch and all other requirements of the substitution rules are enforced.

(D) A pitcher removed from the game or line-up for a substitute may remain in the game in another defensive position provided all other provisions of the substitution rules. Exception: A pitcher who delivers 41 or more pitches in a game cannot play the position of catcher for the remainder of the game. Any player who has played the position of catcher in four or more innings in a game is not eligible to pitch in that game.

(E) A player who is brought in to pitch from another position without benefit of sideline warmup shall be permitted ten (10) warmup pitches or two (2) minutes.

(F) Any player warming up a pitcher on the mound, in a bullpen, or elsewhere shall wear a catcher's mask with helmet and throat protector even if the mask has a manufactured extension at the bottom of the mask. A batting helmet cannot be used to warm up a pitcher.

### **Pitch Count Limitations**

(G) There are no limitations on the number of innings a pitcher may pitch in a tournament (bracket or pool play) game subject to the following pitch count limitations:

- (1) A League Age 10 and under pitcher shall not throw more than 75 pitches in the same game or on the same day. Exception: If the pitcher reaches the maximum pitch count limit while facing a batter, he may continue to pitch until the batter reaches base safely, is put out or, a third out is made on a base-runner to end the half-inning.
- (2) A League Age 11 or 12 pitcher shall not throw more than 85 pitches in the same game or on the same day. Exception: If the pitcher reaches the maximum pitch count limit while facing a batter, he may continue to pitch until the batter reaches base safely, is put out or, a third out is made on a base-runner to end the half-inning.
- (3) All pitchers must adhere to the following pitch count rest requirements before pitching in another tournament game:

### **Tournament Pitching Rest Requirements**

| <b>Required Rest</b> | <b>No Rest</b> | <b>36 Hours</b> | <b>48 Hours</b> |
|----------------------|----------------|-----------------|-----------------|
| <b>Total Pitches</b> | <b>1-40</b>    | <b>41-65</b>    | <b>66+</b>      |

NOTE 1: These pitching rest requirements are based on the number of pitches a player throws in a calendar day. If for any reason, a game ends after midnight, the pitches thrown in the game will be charged to the previous day. The pitcher begins his rest requirement when he leaves the mound in a game and his total cumulative pitch count for the calendar day exceeds 40 pitches. In games suspended by darkness, weather, or other causes and resumed the following calendar day, the pitcher of record at the time the game was halted may continue to the extent of his/her eligibility, provided he/she delivered 40 or less pitches;

NOTE 2: State Option – States may use condensed double-header tournament brackets with modified pitch count restrictions approved by the National Board.

(4) **SUSPENDED GAMES** - In a game suspended by darkness, weather, or other causes and resumed on a following calendar day, the pitcher of record at the time the game was suspended may continue to pitch provided he/she had delivered 40 or less pitches on the calendar day the game was suspended. If the pitcher is eligible to return to the mound when the game is resumed, the pitcher's game pitch count limit will carryover, but the daily pitch count limit will be reset to zero.

(5) A pitcher shall be allowed to pitch in two or more games on the same calendar day provided he/she does not throw more than 40 cumulative pitches in the previous game or games on the same calendar day.

(6) These pitch count limitations will also apply to all games played to determine a district, state or World Series tournament host team or to determine any runner-up teams advancing to the next level of tournament play;

### **Official Pitch Count Record**

(H) The Tournament Director must designate the scorekeeper or another game official as the official pitch count statistician for each game. The pitch count statistician shall record all pitches including strikes, balls, foul tips and any pitches delivered to the catcher ruled a "no pitch" by the umpire. The official pitch count statistician's pitch count is the official pitch count and cannot be protested.

(I) The pitch count statistician must provide the current pitch count for any pitcher when requested by either manager or any umpire. However, the manager has the

ultimate responsibility for knowing his pitcher's pitch count at all times and when his/her pitcher must be removed to meet the rest requirements above.

(J) The official pitch count statistician shall inform the umpire-in-chief when a pitcher has delivered his/her maximum limit of pitches for the game, as noted above. The umpire-in-chief will inform the pitcher's manager that the pitcher must be removed after the current batter reaches base safely or is put out. However, the failure by the pitch count statistician to notify the umpire-in-chief, and/or the failure of the umpire-in-chief to notify the manager, does not relieve the manager of his/her responsibility to remove a pitcher when that pitcher is no longer eligible.

**(K) Protests of an Illegal Pitcher and Penalty shall be handled pursuant to Tournament Rule XII(G). NOTE:** If the pitcher reached his pitch count daily maximum on a previous batter, the pitcher must be removed immediately upon discovery

## **VII. Tournament Games**

(A) All tournament games shall be played to a conclusion regardless of the score or the inning unless the team behind wishes to concede. **State Option:** A state may establish a time limit for all games in tournament pool play and bracket play except for the championship game(s). **(NOTE)** When a suspended game is resumed, play shall begin from the actual point of termination.

**Example A:** The game is called on account of rain in the top half of the third inning with the count of three balls and two strikes on the batter and two outs in the inning. The game shall be resumed at the earliest possible time and play shall resume in the top half of the third inning with the count of three balls and two strikes on the batter and two outs in the inning.

**Example B:** The game is called in the top of the fifth inning for any reason. The game shall be resumed at the earliest possible time from the exact point of termination.

### **EXCEPTIONS:**

(1) **15 RUN RULE** - A game shall be considered a regulation game when a team is ahead by fifteen (15) runs after both teams have batted three times or more and all players on both teams have batted at least once, or in the case of the home team when it is leading, at least two times. Pitchers shall only be charged for innings actually pitched.

**NOTE:** THE VISITING TEAM WILL BE DECLARED

THE WINNER OF A GAME UNDER THE 15 RUN RULE PROVISION ONLY IF THE HOME TEAM HAS HAD AN EQUAL NUMBER OF TIMES AT BAT and all players on both teams have batted at least once.

(2) **10 RUN RULE** - A game shall be considered a regulation game when a team is ahead by ten (10) runs after both teams have batted four times, or in the case of the home team when it is leading, three times. Pitchers shall only be charged for innings actually pitched. **NOTE:** THE VISITING TEAM WILL BE DECLARED THE WINNER OF A GAME UNDER THE TEN-RUN RULE PROVISION ONLY IF THE HOME TEAM HAS HAD AN EQUAL NUMBER OF TIMES AT BAT and all players on both teams have batted at least once.

**NOTE:** If the umpire fails to terminate the game when a ten (10) or fifteen (15) run rule should be invoked, the run rule exceptions shall not apply if the team which has a ten

(10) or fifteen (15) run rule advantage continues to play until there is no longer a ten (10) or fifteen (15) run difference in the score.

**(B) Majors, "O"Zone, and AAA Divisions** - No team shall be required to play more than two (2) games on the same day during the same tournament and no team shall be required to play as many as two (2) games on the same day more than twice during the same tournament, except to play an "if necessary" game to determine the tournament champion. A team playing two (2) games on the same day shall have at least two (2) hours rest between games. In the case of an "if necessary" game to determine a tournament champion there shall be at least one (1) hour rest between games.

**AA and A Divisions** - No team shall be required to play more than three (3) games on the same day during the same tournament and no team shall be required to play as many as three (3) games on the same day more than twice during the same tournament, except to play an "if necessary" game to determine the tournament champion. A team playing three (3) games on the same day shall have at least one and one half (1 1/2) hours rest between games. In the case of an "if necessary" game to determine a tournament champion there shall be at least one (1) hour rest between games.

(C) The Commissioner shall be empowered to waive any tournament rule deemed necessary to ensure the completion of any tournament where there have been delays caused by inclement weather or other reasons.

(D) Only baseballs stamped "Official DYB Baseball" and bearing the Commissioner's signature shall be used in any tournament. Manufacturers of approved balls will be announced by the Commissioner.

(E) If games are played under floodlights at any level of tournament play, the approval of the DYB official in charge of that tournament must be received before the start of the tournament.

(F) All rained-out or postponed games shall be rescheduled by the tournament director in the order of postponement. For example: Game 3 is postponed due to rain, wet grounds or for any other reason, but the ground crew gets the field in condition to play again several hours later. Game 3 shall be played before any other game on the schedule.

(G) Teams forfeiting games in tournament competition may not be granted tournament privileges the following year.

### **VIII. Player Participation Requirement**

(A) Every available player on a team's tournament roster must meet the offensive and defensive requirements specified in paragraphs (B) - (F) below which providesthat:

(1) Each player must complete one time at bat in every tournament or series game played by his team (See definition- Complete Time at Bat in Rule 2.00); **PENALTY** - The penalty for violation of IX(A)(1) shall be the disqualification of the team manager for the remainder of the game and the remainder of the next game played by his team in the tournament or series, and

(2) Each player must play on defense six outs (three consecutive outs in two different innings) in any game played by his/her team. **PENALTY** - The penalty for violation of IX(A)(2) shall be the disqualification of the team manager for the remainder of the game and the next game played by his team in the tournament or series. Exception: If the manager refuses to insert players into the defensive lineup during a game after being notified by the official scorer or a DYB official that a player or players on the team has not met the participation requirement, these players shall be inserted in the game by the tournament director and the team manager shall be removed from the team immediately and disqualified



for the remainder of the current tournament season. NOTE: These penalties shall apply to both teams, even if the last half of the sixth inning is not required. The only exceptions shall be when the game is considered a regulation game but is not completed in six innings (five and one-half innings with the Home Team leading) because of the 10 or 15 run-rule, or when a team concedes before all available players have participated.

**(B) Offensive Participation Requirements** – The tournament director shall notify each manager whether the tournament offensive participation requirement will use a continuous batting order throughout the game or revert to a nine-man order after all available players on the roster have batted one time.

**(C) Continuous Batting Order (Reverting to Nine Man Batting Order)**

(1) At the start of the game, all available players on each tournament team roster will be listed in the starting offensive batting lineup and bat in this order until all have completed one turn at bat. After all players in the initial batting lineup have batted once, the official offensive lineup will revert to the first nine players listed in the original batting lineup for the remainder of the game. The players not listed in first nine batting positions will become official substitutes and will be eligible to return to the official batting lineup in one of the first nine offensive batting lineup positions at any time.

(2) If a player arrives after the batting order has been submitted but before the initial time through the batting order has been completed, the player must be added to the end of the batting order. If the batting order has reverted back to the original nine-man order, a player arriving before the fourth inning has been completed must fulfill his batting requirement by substituting for a player in the top nine positions of the batting order and must play defense. If a player arrives after the fifth inning has begun, he SHALL NOT participate in the game.

(3) The batting position of a player who leaves the game because of an injury, illness or disqualification BEFORE THE LINEUP REVERTS TO A NINE-MAN BATTING ORDER shall be:

(a) Skipped if player is not listed in one of the top nine positions of the batting lineup;

(b) Replaced if player is listed in one of the top nine positions of the batting lineup by a substitute player who is not listed in one of top nine positions of the batting lineup; Note: If the substitute resumes the substituted players' count to complete his at-bat, he will not bat again unless he remains in the batting position of the substituted player;

(c) No player will be called "out" who is skipped by rule in the batting lineup.

(4) Any player listed in the top nine batting positions who leaves the game because of an injury, illness or disqualification after all players have batted once in a Continuous Batting Line-up [which reverts to a nine-man lineup] will be substituted by an available player who was not listed in the top nine batting positions. If the player is injured while at bat, the substitute batter will assume his count.

(5) If a manager has used all his eligible players and a player is injured or becomes ill and cannot continue, the game shall not be forfeited. The opposing manager shall select a player from the bench who has already been in the game to replace the injured or ill player in the injured or ill player's batting position.

**(D) Continuous Batting Order** – The Board of Directors of DYB has granted each state organization the right to use the continuous batting order in tournament play through the state tournament level. TOURNAMENT RULE IX(C) will be used in the

Division I and Division II DYB Majors, “O”Zone and AAA World Series and in all tournaments, which do not use the continuous batting order rule.

(1) At the start of the game, all available players on each tournament team roster will be listed in the starting offensive batting lineup and bat in this order continuously throughout the game.

(2) If a player arrives after the continuous batting order has been submitted to the scorer, the player must be added to the end of the continuous batting order. Players who arrive late shall be substituted for the next batter in the lineup when they enter a game late and have them bat immediately only if the late player cannot mathematically have a plate appearance. If this is the case, then the substituted player will skip his at-bat once and the substitute player will go to the last position in the batting order for the remainder of the game. If a player arrives after the fifth inning has begun, he SHALL NOT participate in the game.

(3) If a player listed in any batting position in a continuous batting lineup leaves the game because of an injury, illness or disqualification, this position in the batting lineup will be skipped for the remainder of the game without penalty. No player will be called “out” who is skipped by rule in the batting lineup.

(4) If the player is injured while at bat, the next batter will assume his count. EXCEPTION: If the player is a base runner, the player in the batting lineup who was last putout will become a substitute runner for the player who has left the game due to an injury and the substitute runner shall not change his position in the batting line-up.

(E) A player removed because of injury or illness may return to the game, if otherwise eligible.

#### **(F) Defensive Participation Requirement**

(1) At the start of the game, all available players on each tournament team roster will be listed in the starting offensive batting lineup and the defensive starters shall be designated on the team lineup card. Any defensive player, including the pitcher, may be listed in any order on the starting offensive batting lineup.

(2) **Defensive participation requirement** - Each player must play on defense six outs (three consecutive outs in two different innings) in any game played by his/her team. Each team manager is responsible for playing each available player on the tournament team roster defensively for three consecutive outs in two different innings.

(3) Each scorer shall indicate in the official scorebook in which inning (or innings) a player met the defensive participation requirement.

(4) The scorer shall notify the team manager and umpire of any player who has not met this requirement at the completion of the fourth inning of play. The tournament director shall notify the umpire to direct such manager to insert in the team’s defensive fifth inning any such player(s) who have not met the defensive participation requirement.

(5) **FREE SUBSTITUTION ON DEFENSE!** (Tournament Play Only)

(a) With the exception of the pitcher in Majors, “O”Zone and AAA Division play, any player may enter the game on defense in any defensive position as many times as deemed necessary by the team manager.

(b) Players may enter the game on defense only at the beginning of each team's defensive inning unless the defensive player enters the game to replace an injured, ill or ejected player or enters the game during a pitching change. Entering the game on defense does not count as entering/re-entering on offense for the purposes of Rule 3.03(a).

(c) All offensive changes to the batting line-up must be recorded in the official score book and shall be governed by the substitution rules in Rule 3.03(a).

(d) The public-address announcer shall maintain a score card for defensive changes. It is recommended that all changes be announced over the public-address system.

The Board of Directors of DYB has granted each state organization the right to use the twelve-player batting order in tournament play through state tournament level. A written plan, approved by the state organization for use of the rule, must be submitted to the Commissioner for final approval prior to the beginning of tournament play. REGULATION IX (C) OFFENSIVE PARTICIPATION REQUIREMENT remains in effect in all tournaments in states that do not choose to use the continuous batting order rule and will be used in the DYB World Series.

## **IX. Tournament Uniforms**

(A) All players in tournament play shall wear regular baseball uniforms. No plain, unnumbered, undershirt style T-shirts shall be permitted for uniform jerseys. Uniform type T-shirts in team colors with numbers shall be considered legal regular baseball uniforms. Coaches may wear the same baseball uniform of the team or matching shirts. The penalty for violation of this rule is possible disqualification of the team by the tournament director from further play. The District Director, State Director and Commissioner shall establish an appropriate dress code for each level of tournament play so as to portray the proper image for DYB.

(B) All players and coaches participating in sanctioned DYB tournaments shall wear an approved "official" DYB patch. on the left shirt sleeve and the DYB World Series patch shall be worn on the right sleeve of World Series uniforms. The official DYB insignias shall not be screen printed on the uniform but must be the embroidered emblems issued by DYB

**NOTE: Older embroidered emblems with the DYB logo are also permitted on tournament uniforms.**

(C) All players participating shall have numbers not less than four inches on the back of their uniform shirt. Any players wearing a batting vest shall also have numbers not less than two inches on their sleeve, (preferably the right sleeve). No duplicate numbers shall be allowed. **PENALTY:** The penalty for violation of this rule shall be that players wearing duplicate numbers shall not be allowed on the field.

(D) All state championship teams advancing to a DYB World Series and the host team may purchase, if not provided by the state organization, T-shirts with the DYB insignia and the name of their state [or league name if the host team] for the players and managers of the teams.

(E) The DYB World Series host shall present to the DYB World Series championship team a flag four feet by six feet with the DYB insignia.

(F) All players and managers must present a neat and clean appearance. Hair length should not extend over the eyes and interfere with vision.

## **X. Conduct and Sportsmanship**

(A) Members of a team shall not ride, kid, heckle, poke fun at or in any other manner do anything that in the opinion of the umpire distracts the opposing team. A player shall not throw a bat, helmet or other equipment in anger or disgust. The penalty for violation of this rule shall be the removal of the guilty player from the game for the remainder of the game. The penalty for violation of this rule by a manager or coach shall be his removal from the game and the dugout for the remainder of the game.

(B) Tournament directors, at their discretion, may allow the use of noisemakers. However, spectators may not use noisemakers in an attempt to distract the pitcher's delivery of the pitch to the batter. Any such action will be deemed unsportsmanlike conduct and will not be permitted by the umpire. The tournament director may request the tournament host, as permitted by local and state law, to remove from the tournament playing facilities any spectator who fails to discontinue the use of noisemakers after the umpire-in-chief announces their use is banned for the remainder of the game.

(C) When a batter wiggles the bat in an EXTREME MANNER in which, in the umpire's opinion, the batter is intentionally attempting to distract the pitcher's delivery of the pitch to the batter, this action shall be deemed unsportsmanlike conduct and not permitted. The umpire shall call a no pitch and meet with the batter and manager to give a warning upon its first occurrence. Upon a second occurrence, the team manager shall be cited for unsportsmanlike conduct and removed for the remainder of the game.

(D) The fake bunt/hit away tactic will not be allowed. Aggressive defensive play brings the players too close to the batter in an attempt to take the bunt away from the batter completely, which becomes a safety concern. Once a batter squares to bunt, he may:

- (1) Pull the bat back and take the pitch, or
- (2) Attempt to bunt the ball.

The batter may not swing away after squaring off in the bunt position and drawing a fielder dangerously close to the batter's box. The umpire shall call no pitch and meet with the team and team manager to give a team warning upon the first occurrence. **A second occurrence will result in the player being called out.**

(E) **Slinging the Bat** - After one warning per game, per player for slinging the bat, the batter will be out, a dead ball called, and no runners advance.

(F) The use of any alcoholic beverage or tobacco product (including e-cigarettes) within the confines of the playing field, dugout or bench by any manager, coach, player, umpire or league official is prohibited. The penalty for violation of this rule shall be the removal of the guilty manager, coach, player, umpire or official from the game and from the dugout.

(G) Tournament hosts have the authority, as permitted by local and state law, to remove or ban from the league's playing facilities any spectator who is flagrantly displaying unsportsmanlike conduct, profanity, or who threatens physical harm to umpires, players, managers, coaches or league officials. This authority extends to all scheduled tournament games played at its playing facilities.

## XI. Protests & Protest Appeals

(THESE RULES REPLACE THE REGULAR SEASON PROTEST RULES.)

(A) Only the team manager or the acting team manager shall be entitled to file a protest relating to any rule or regulation which applies to the 7-8, 9-10 and 11-12 age divisions during any tournament game or between games if permitted by rule.

(B) Protests shall be made only on a misinterpretation of a rule published in the current edition of the “Official Rules & Regulations of DYB”, including but not limited to, provisions for the ineligibility of a player or players, an illegal substitution, an illegal pitcher or failure to comply with the participation requirement. —A protest which clearly requires an umpire’s judgment shall not be accepted by the tournament director.

(C) All protests of rule violations, except protests of an ineligible player, an illegal pitcher or failure to comply with the participation requirement, must be made to the umpire-in-chief immediately after the occurrence of the violation and before another pitched ball is thrown to a batter. The umpire-in-chief shall discuss any disputed ruling with any umpire involved in the play and/ or may consult with umpires not involved in the play to determine if the ruling, in their opinion, was in accordance with DYB Rules and Regulations.

(D) The umpire-in-chief shall explain the disputed rule to each team manager and specify whether the ruling decision will stand or be reversed. If either team manager does not agree with the umpire’s explanation of the ruling, the umpire-in- chief shall refer the protest to the tournament director. **NOTE:** Either manager has the right to put his team in the dugout and refuse to continue play if the umpire-in- chief does not refer any protest to the tournament director.

**(E) AFTER THE COMPLETION OF A GAME THERE SHALL BE NO PROTEST REGARDLESS OF THE CIRCUMSTANCES INVOLVED WITH THE EXCEPTION OF A PROTEST ON ELIGIBILITY AS PRESCRIBED BY TOURNAMENT RULE XI (H(2)) OR THE FAILURE OF A TOURNAMENT OFFICIAL TO FOLLOW PROPER PROCEDURES FOR HANDLING PROTEST APPEALS.**

**NOTE:** A game shall not be considered as complete until opposing managers have an opportunity to make a protest on a game ending play or failure to comply with the participation requirement. Fifteen minutes shall be considered sufficient time for the fulfillment of this rule.

(F) When the official scorer or other officials have knowledge of a potential illegal substitution of a player or use of an illegal pitcher, they should advise the manager of the violating team. However, after the violation occurs, no one shall call attention to the violation except the opposing manager.

**(G) ILLEGAL PITCHER**—If an illegal pitcher enters the game, or becomes illegal after entering the game, this is a continuing violation and may be protested at any time during its continuation prior to the completion of the game. **PENALTY:**

If protested during the game, the illegal pitcher shall be removed from the mound and the offended team shall have the choice of replaying the game from the point where the illegal pitcher entered the game to pitch or became illegal after entering the game or continue from the point where the illegal pitcher is removed from the game. If, in the opinion of the tournament director, the violation was intentional, the tournament team manager shall be disqualified from further tournament play.

(H) (1) An **INELIGIBLE PLAYER** is a player who is ineligible to be a member of a tournament team for a league because he does not live within the approved boundary of the league, a player who did not meet the participation requirements in his/her league, a player who violates Tournament Rule IV(C) or, a player who is older than the maximum league age allowed for the respective age division of play.

(2) All protests based on the ineligibility of a player, other than age, shall be filed with the appropriate DYB official prior to the conclusion of the first tournament game played by that player. **PENALTY:** The penalty shall be the immediate removal of the player from his/her DYB tournament team roster and disqualification from tournament play.

(3) A protest of eligibility based on age may be presented to the tournament director at any time during tournament play. **PENALTY:** If, in the opinion of the tournament director, there is sufficient evidence of an age violation but there is no **WILLFUL VIOLATION** of the age eligibility rules, the tournament director shall disqualify the player from further tournament play. If in the opinion of the tournament director, there is sufficient evidence of a **WILLFUL VIOLATION** of age eligibility rules, the tournament director shall forfeit the last game played by the team and the team shall be disqualified from tournament play.

(I) **INELIGIBLE MANAGER/COACH** – Any tournament team manager or coach who violates Tournament Rule IV(C) will be removed from his DYB tournament team immediately.

#### (J) **PROTEST APPEAL PROCEDURES**

(1) Appeals of protest decisions in AA, AAA, Majors or “O” Zone tournament games may be carried to the Tournament Director, the State Director and up to the Commissioner if so desired but play may not resume until a decision is accepted by both managers or the appeal process is exhausted. Failure to get a final decision through proper appeals before the next pitch is thrown to a batter or before a play is made on a runner will forfeit the right for any further appeal by either team manager.

(2) As provided in Tournament Rule XII(D) above, the Umpire-In Chief shall refer any protest to the Tournament Director who may interview the umpires or the team managers before making a decision. After the Tournament Director renders a decision, either manager can request an appeal to the State Director.

(3) The Tournament Director **ONLY** shall be permitted to call the State Director. The State Director may interview the Tournament Director, the umpires or the team managers before making a decision. After the State Director renders his decision, either manager can request the State Director to appeal to the Commissioner.

(4) The Commissioner of DYB shall be called **ONLY** by the State Director for a **FINAL DECISION** on any appeal of a State Director’s decision. The Commissioner may reserve the right to speak with the Tournament Director, any umpire in the game or any team manager before making his decision. The Commissioner’s decision will be communicated only to the State Director who will inform the Tournament Director.

(5) After a ruling by the DYB Commissioner no further appeals can be made, and play must continue immediately.

(6) No appeal shall be accepted by any Tournament Director or State Director or by the Commissioner in tournament competition on the grounds of a violation of local league rules during regular season play and this shall include population or boundary violations.

(7) There shall be no appeal of any protest occurring during an A (T-Ball) Division tournament beyond the District Director unless otherwise provided in an individual state's constitution and bylaws.

(8) Appeals will be allowed only if presented exactly according to the above procedures. Team managers may only request an appeal. Managers cannot present appeals directly to these officials. All officials will be available to receive protest appeals during the tournament season.

## **XII. Umpires**

(A) The Commissioner shall approve the umpires for the DYB World Series, the state director shall approve umpires for the state tournament and the district director shall approve umpires for district tournaments or below.

(B) Whenever possible, it is recommended that umpires be selected who have not officiated in games of the participating leagues. An umpire shall not officiate as umpire-in-chief in more than two games in the same calendar day.

(C) All umpires shall report IN WRITING to the TOURNAMENT DIRECTOR before leaving the ball park ANY violations leading to the disqualification of any manager, coach, player or DYB official and the reasons therefore.

(D) With respect to any manager, coach, player, spectator or DYB official disqualified for a flagrant offense such as the use of obscene or indecent language, boisterous behavior or an assault on an umpire, manager, coach, player or DYB official, the umpire shall forward full details to the TOURNAMENT DIRECTOR before leaving the ball park the night of the infraction.

(E) This report shall be filed with the TOURNAMENT DIRECTOR and, at the World Series only, with the World Series Umpire Committee to be reviewed for accuracy and clarity. These reports shall be distributed within 12 hours of the conclusion of the game in question or prior to play resuming the following day.

## **XIII. Awards**

(A) Team awards shall be presented to the championship, runner(s)-up and/or third place teams at the DYB World Series. Individual awards shall be presented to each player, manager and coach of the championship and runner(s)-up teams.

(B) The Majors team championship award shall be presented and known as the Matt Goyak Championship Trophy. A Majors team sportsmanship award shall be presented and known as the Danny Jones Sportsmanship Trophy.

(C) The AAA team championship award shall be presented and known as "The Tom Linton Championship Trophy". The AAA team sportsmanship award shall be presented and known as the Bill Harth Sportsmanship Trophy.

(D) The "O"Zone team sportsmanship award shall be presented and known as the George Pinner Sportsmanship Trophy

# AA Coach Pitch Tournament Rules

## XV. AA Coach Pitch Tournament Rules

The following AA Coach Pitch Tournament Rules shall be used exclusively in AA Coach Pitch district and state tournament play and in the Division I & II Coach Pitch World Series. The Official DYB playing and tournament rules as currently in use will be the basic set of rules for AA Division play with the exception of the rules emphasized or modified for AA play only listed below:

### (A) Tournament Play:

- (1) A game will be a forfeit if a team cannot field nine players.
- (2) No game shall start after 9:30 pm unless approved by the Tournament Director.
- (3) Tournament games must be played until complete. **State Option:** The state may impose a time limit in AA games.
- (4) Balls must be DYB Approved for tournament play.
- (5) A minimum of two umpires per game is required.
- (6) All Division I AA Coach Pitch tournament team affidavits must consist of twelve (12) players, a team manager, and three coaches.
- (7) **All Division II** AA Coach Pitch tournament team affidavits must consist of eleven (11) players, a team manager, and three coaches.
- (8) All Division I & II tournament teams must begin each level of tournament play with a full roster of players and coaches.
- (9) **AA World Series Play** - If three teams are tied at 1-1 after three-team pool play ends, the tie-breaker rules will be used to determine the first, second and third seeds to advance to the AA Division I and II Coach Pitch Championship bracket. After pool play, all 12 teams will advance to the championship bracket.

### (B) Playing Field:

- (1) Baselines shall be 60 feet.
- (2) Recommended minimum distance for the outfield fence to be 160 feet from home plate. Approved temporary fencing will be allowed.
- (3) A 12-foot-diameter chalked or painted pitching circle (the "pitching circle") with a chalked or painted line in the center of the pitching circle at 46 feet drawn completely across the circle is the designated pitching area. The center of the pitching circle will be 46 feet from the back edge of home plate.

### (C) AA Coach Eligibility:

- (1) Only managers, assistant managers or coaches during the regular league season shall be eligible to manage or coach a tournament team and they shall be registered on their regular season team player rosters as filed with the district and state directors. The state director shall be empowered to grant exceptions to this rule.
- (2) There must be four (4) coaches listed on the tournament team roster affidavit.
- (3) Three (3) coaches will be allowed on the playing field at one time, two (2) base coaches, and one (1) pitching coach.
- (4) The fourth (4th) coach must remain in the dugout at all times to supervise the players.



#### **(D) Coach Pitch**

(1) The adult coach pitcher of the offensive team shall pitch to the batters and he shall throw overhand from standing position.

(2) The coach pitcher must pitch from within the designated pitching circle with the coach pitcher's feet remaining in the designated pitching circle until the pitch is released. **NOTE:** Coach pitcher does not have to pitch from the pitching rubber or half-way mark in the pitching circle. If one foot is within the circle and any part of the other foot is in contact with the chalk or paint outlining the circle when the pitch is released the coach will be considered in the circle. **PENALTY:** If the coach pitcher does not remain in the circle, a violation shall be called by the umpire with the defensive team having the option of taking the play or a no pitch.

(3) The coach pitcher shall exit the playing field behind the runner or away from any play on the field when the ball is hit into fair play to avoid interference. **PENALTY:** If the umpire determines interference on the coach pitcher, the batter shall be declared out and all runners shall return to the base occupied at the time of the pitch. The coach pitcher shall be warned and a second occurrence in the game shall result in the removal of the coach pitcher from the mound to the dugout for the remainder of the game.

(4) If the coach pitcher is hit by the ball, it is a dead ball and will be declared a no pitch.

(5) The coach pitcher may coach or position the batter only, prior to the delivery of a pitch. He/she cannot coach the runners. **PENALTY:** A warning will be given for first offense and he/she will be removed from the mound to the dugout for the remainder of the game on the second offense.

given for first offense and he/she will be removed from the mound to the dugout for the remainder of the game on the second offense.

(6) Only the manager shall represent or speak for the team.

(7) Coaches cannot go outside the playing field without the permission of the umpire. Coaches will be removed from the game for violation.

(8) The Coach Pitcher cannot leave the mound and return to the mound during the same inning with the exception of an illness or injury.

#### **(E) Player Pitcher Position (Coach Pitch)**

(1) The defensive team will place a player in the designated pitching circle at the pitcher position. The player pitcher must have one foot inside the designated pitching circle, must stand in position on either the left side or the right of the coach pitcher or behind the coach pitcher, must not interfere with the coach pitcher, and not be any closer to the batter than even with the 46-foot line until the ball is hit. The Player Pitcher cannot leave the designated circle until the ball is hit. **PENALTY:** The offensive coach has the option of accepting a hit or taking a no pitch.

(2) The player pitcher is required to wear a face guard with or without a batting helmet or cap while playing this position.

(3) Tournament Pitching Rules (VII) do not apply to the player pitching position.

#### **(F) Equipment**

(1) Catchers must wear full catcher protective equipment. The catcher may use a baseball fielder's glove or catcher's mitt. The catcher must be in the squatting position behind home plate in a direct line with the pitcher and home plate when the ball is pitched.

(2) The player pitcher is required to wear a face guard with or without a batting helmet or cap while playing this position.

**(G) General Playing Rules:**

(1) The infield fly rule is NOT applicable.

(2) Bunting is NOT allowed. **PENALTY:** If a player bunts a ball in fair territory, it is a violation of this rule and the umpire shall immediately call time; no players may advance, and the batter will be charged with a pitch and a strike.

(3) Base stealing is NOT allowed.

(4) Intentional walks will not be allowed

(5) A regulation game shall be six (6) innings for tournament play in all AA games unless the 10 or 15-run rule applies (Fifteen runs after three (3) innings or ten runs after four (4) innings).

(6) The 15-run rule will apply after three innings only if all players have completed one time at bat.

(7) The batter will be allowed five (5) pitches or three (3) strikes. The batter will be called out after the fifth (5th) pitch unless the fifth pitch is a foul ball. A foul on the last pitch shall not count unless a foul fly is caught in the air; then the batter is declared out.

(8) The outfielders may play anywhere in the outfield but no closer than twenty feet behind the normal base path. A chalked or painted line will be placed at the twenty-foot point. . “Penalty: The offensive coach has the option of accepting the hit or taking a no pitch. Note: This line pertains to the four outfielders only, not to the infielders. Once a ball has been hit by the batter the outfielder may move inside the 20’ line to make a play on the ball”

(9) A game will be a forfeited if a team cannot field nine players in a AA game.

(10) Teams on defense will use a total of ten players in the field, including four outfielders.

**State Option:** A state organization may adopt a rule to allow a team to score a maximum of seven runs per half-inning, except the 6th inning in district and/or state tournament play. After the 6th inning, the seven (7) run maximum is in force for the remainder of the game.

**(H) Base Running:**

(1) If a runner has passed a base prior to the player pitcher gaining control of the ball in the designated pitching circle and does not stop, he/she may advance to the next base at his/her own risk.

(2) With runners on base, a timeout will be called by the umpire after each play comes to a natural end.

(3) A runner missing a base with no attempt to return to the base to tag up before the ball becomes dead may be appealed by the coach after calling a time out.

**PENALTY:** The runner shall be called out on appeal.

(4) A courtesy runner may be used for the catcher only by the player who made the last out in the continuous batting order. “Courtesy runners” are not permitted for other playing positions.

## (I) Player Participation Requirements

(1) **Offensive participation requirement.** All players will bat in a continuous batting order. At the start of the game, all available players on each tournament team roster will be listed in the starting offensive batting line up and bat in this order for the entire game. If a player becomes injured **or** ill while on base the previous player making an out shall run for him/her.

(2) If a player arrives after the continuous batting order has been submitted to the scorer, the player must be added to the end of the continuous batting order. Players who arrive late shall be substituted for the next batter in the lineup when they enter a game late and have them bat immediately only if the late player cannot mathematically have a plate appearance. If this is the case, then the substituted player will skip his at-bat once and the substituted player will go to the last position in the batting order for the remainder of the game. If a player arrives after the fifth inning has begun, he **SHALL NOT** participate in the game.

(3) A player who becomes ill or injured and leaves the game may later return to the same place in the batting order as when he/she left the game.

(4) **Defensive participation requirement** - Each player must play on defense six outs (three consecutive outs in two different innings) in any game played by his/her team. Each team manager is responsible for playing each available player on the tournament team roster defensively for three consecutive outs in two different innings.

(5) **FREE SUBSTITUTION ON DEFENSE!** (Tournament Play Only)

(a) Players may enter the game on defense only at the beginning of each team's defensive inning unless the defensive player enters the game to replace an injured, ill or ejected player or enters the game during a pitching change. Entering the game on defense with the exception of the pitcher does not count as entering/re-entering on offense for the purposes of Rule 3.03(a).

(b) All offensive changes to the batting line-up must be recorded in the official score book and shall be governed by the substitution rules in Rule 3.03(a).

(c) The public-address announcer shall maintain a score card for defensive changes.

(d) It is recommended that all changes be announced over the public-address system.



# OFFICIAL DYB THREE-TEAM DOUBLE ELIMINATION BRACKET

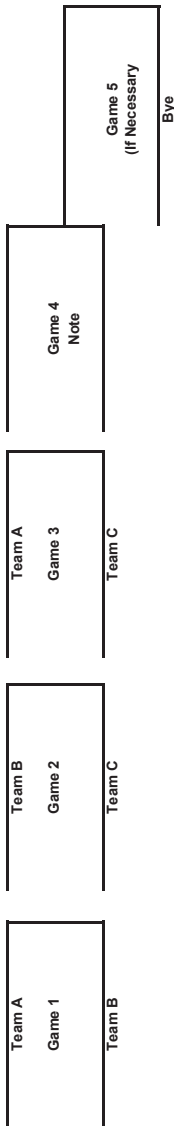

**NOTE:** Advancing More Than One Team from Tournament Bracket – Any two tied teams with the same won-loss record after completion of this double elimination bracket must play a one game playoff to determine which team advances where more than one team advances to the next level of tournament play. **EXCEPTION:** The head-to-head tie-breaker may be used in lieu of a play-off game if the teams have played each other during the tournament. No other tie breakers may be used.

**NOTE:** If three (3) teams remain with one loss each after Game #3, a drawing will be held for the Game #5 Bye. The other two teams will play in Game #4. If only two teams remain after Game #3, they will play Game #4 and Game #5 if necessary.



# OFFICIAL DYB FOUR-TEAM DOUBLE ELIMINATION BRACKET

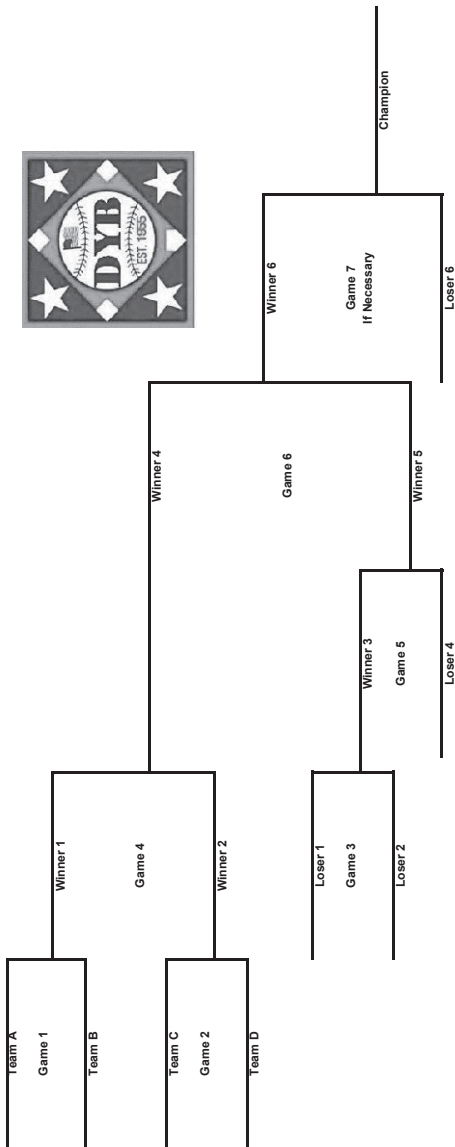

**NOTE:** Advancing More Than One Team from Tournament Bracket

- Any two tied teams with the same won-loss record after completion of this double elimination bracket must play a one game playoff to determine which team advances where more than one team advances to the next level of tournament play.

**EXCEPTION:** The head-to-head tie-breaker may be used in lieu of a play-off game if the teams have played each other during the tournament. No other tie breakers may be used.

# Round-Robin Tournament Formats

The Commissioner allows the use the round-robin format for three, four or five team tournaments. The Commissioner strongly recommends the use of the round robin format in five team tournaments, especially where more than one team will advance to the next level of play. The three-team double elimination bracket is really a round-robin format. The only difference between the brackets in the book and the round-robin format is that the bye is determined by a draw and the bye is determined by the tie-breaker rules in the round robin format. All tournaments should indicate whether it is a double elimination format or a round-robin format.

## **Four Team Round Robin (Single Round)**

|                     | <u>Visitor - Home</u>   |
|---------------------|-------------------------|
| <b>Day 1 Game 1</b> | <b>Team A vs Team B</b> |
| <b>Day 1 Game 2</b> | <b>Team C vs Team D</b> |
| <b>Day 2 Game 3</b> | <b>Team D vs Team A</b> |
| <b>Day 2 Game 4</b> | <b>Team B vs Team C</b> |
| <b>Day 3 Game 5</b> | <b>Team A vs Team C</b> |
| <b>Day 3 Game 6</b> | <b>Team B vs Team D</b> |
| <b>Day 4 Game 7</b> | <b>Note 1</b>           |
| <b>Day 4 Game 8</b> | <b>Note 1</b>           |

### Note 1 - Playoffs

(a) After Game 6, if two teams are tied for first place and two teams are tied for third place, the two teams tied for first place shall play a one game playoff in Game 7 for first and second place. The two teams tied for third place shall play a one game playoff in Game 8 for third and fourth place.

(b) After Game 6, if three teams are tied for first place, the tie-breaker rules will apply to determine which team draws a bye to Game 8 and the remaining two teams shall play in Game 7 for the right to meet the team which drew the bye in Game 8.

### Tie Breakers

Rule 1. Head-to-Head Record Between Tied Teams

Rule 2. Least Runs Allowed Between Tied Teams

Rule 3. Least Runs Allowed for the Tournament

Rule 4. Most Runs Scored for the Tournament

Rule 5. Coin Flip

**State Option:** The state organization may elect to not use the playoff schedule in Note 1 above and determine the order of finish strictly by tie-breakers only as follows: If three or more teams are tied with the same won-lost record, apply each tie-breaker rule in order until you break out a team; then, apply each tie-breaker rule in order for the remaining teams until you break out a second team, and so on until all ties are broken.

### Four Team Round Robin Double Round}

|              |                | <u>Visitor - Home</u>   |
|--------------|----------------|-------------------------|
| <b>Day 1</b> | <b>Game 1</b>  | <b>Team A vs Team B</b> |
| <b>Day 1</b> | <b>Game 2</b>  | <b>Team C vs Team D</b> |
| <b>Day 2</b> | <b>Game 3</b>  | <b>Team D vs Team A</b> |
| <b>Day 2</b> | <b>Game 4</b>  | <b>Team B vs Team C</b> |
| <b>Day 3</b> | <b>Game 5</b>  | <b>Team A vs Team C</b> |
| <b>Day 3</b> | <b>Game 6</b>  | <b>Team B vs Team D</b> |
| <b>Day 4</b> | <b>Game 7</b>  | <b>Team D vs Team C</b> |
| <b>Day 4</b> | <b>Game 8</b>  | <b>Team B vs Team A</b> |
| <b>Day 5</b> | <b>Game 9</b>  | <b>Team C vs Team B</b> |
| <b>Day 5</b> | <b>Game 10</b> | <b>Team A vs Team D</b> |
| <b>Day 6</b> | <b>Game 11</b> | <b>Team B vs Team D</b> |
| <b>Day 6</b> | <b>Game 12</b> | <b>Team C vs Team A</b> |
| <b>Day 7</b> | <b>Game 13</b> | <b>Note 1</b>           |
| <b>Day 7</b> | <b>Game 14</b> | <b>Note 1</b>           |
| <b>Day 7</b> | <b>Game 15</b> | <b>Note 1</b>           |

### Note 1 - Playoffs

(a) After Game 12, if two teams are tied for first place and two teams are tied for third place, the two teams tied for first place shall play a one game playoff in Game 13 for first and second place. The two teams tied for third place shall play a one game playoff in Game 14 for third and fourth place.

(b) After Game 14, if three teams are tied for first, second or third place, the tie-breaker rules will apply to determine which team draws a bye to Game 14 and the remaining two teams shall play in Game 13 for the right to meet the team which drew the bye in Game 14.

(c) After Game 12, if two teams are tied for first, second or third place, the two teams shall play in a one game playoff in Game 13.

(d) After Game 12, if all four teams have the same record, the tie breakers will be used to pair the top two teams to play in Game 13. The next two teams will play in Game 14. The winners of Game 13 and Game 14 will play Game 15 for the championship.

The tie breakers will be used to determine third and fourth place between the two teams which lost Games 13 and 14.

### Tie Breakers

- Rule 1. Head-to-Head Record Between Tied Teams
- Rule 2. Least Runs Allowed Between Tied Teams
- Rule 3. Least Runs Allowed for the Tournament
- Rule 4. Most Runs Scored for the Tournament
- Rule 5. Coin Flip

**State Option:** The state organization may elect to not use the playoff schedule in Note I above and determine the order of finish strictly by tie-breakers only as follows: If three or more teams are tied with the same won-lost record, apply each tie-breaker rule in order until you break out a team; then, apply each tie-breaker rule in order for the remaining teams until you break out a second team, and so on until all ties are broken.

### Five Team Round Robin

#### Visitor - Home

|                      |                         |
|----------------------|-------------------------|
| <b>Day 1 Game 1</b>  | <b>Team A vs Team B</b> |
| <b>Day 1 Game 2</b>  | <b>Team C vs Team D</b> |
| <b>Day 2 Game 3</b>  | <b>Team A vs Team E</b> |
| <b>Day 2 Game 4</b>  | <b>Team B vs Team C</b> |
| <b>Day 3 Game 5</b>  | <b>Team D vs Team E</b> |
| <b>Day 3 Game 6</b>  | <b>Team C vs Team A</b> |
| <b>Day 4 Game 7</b>  | <b>Team E vs Team C</b> |
| <b>Day 4 Game 8</b>  | <b>Team B vs Team D</b> |
| <b>Day 5 Game 9</b>  | <b>Team E vs Team B</b> |
| <b>Day 5 Game 10</b> | <b>Team D vs Team A</b> |
| <b>Day 6 Game 11</b> | <b>Note 1</b>           |
| <b>Day 6 Game 12</b> | <b>Note 1</b>           |

#### Note 1

- If two teams are tied for first place, they shall play Game 11 in a one game playoff for first and second place;
- If two teams are tied for second place, they shall play Game 12 in a one game play off for third and fourth place;
- If three teams are tied for first place, the team which wins the tie-breaker will receive a bye to game 12 and play winner of Game 11;
- If three teams are tied for second place, the team which wins the tie-breaker will receive a bye to Game 12 and play winner of Game 11;
- If five teams are tied for first place, the tie-breakers below shall be used to determine their order of finish in the tournament.

#### Tie Breakers

Rule 1. Head-to-Head Record Between Tied Teams

Rule 2. Least Runs Allowed Between Tied Teams

Rule 3. Least Runs Allowed for the Tournament

Rule 4. Most Runs Scored for the Tournament

Rule 5. Coin Flip

**State Option:** The state organization may elect to not use the playoff schedule in Note 1 above and determine the order of finish strictly by tie-breakers only as follows:

If three or more teams are tied with the same won-lost record, apply each tie-breaker rule in order until you break out a team; then, apply each tie-breaker rule in order for the remaining teams until you break out a second team, and so on until all ties are broken.



# OFFICIAL DYB FIVE-TEAM DOUBLE ELIMINATION BRACKET

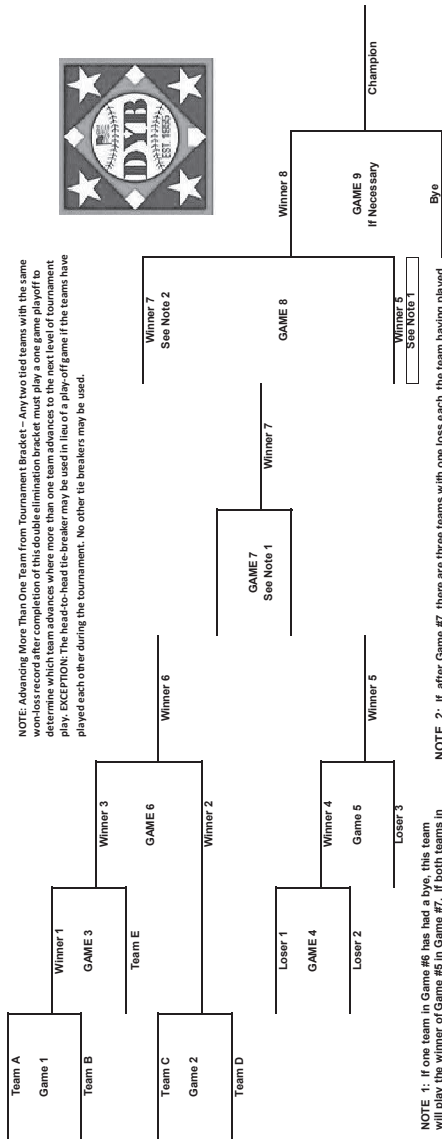

**NOTE:** Advancing More Than One Team from Tournament Bracket—Any two tied teams with the same win-loss record after completion of this double elimination bracket must play a one game playoff to determine which team advances where more than one team advances to the next level of tournament play. **EXCEPTION:** The head-to-head tie-breaker may be used in lieu of a play-off game if the teams have played each other during the tournament. No other tie breakers may be used.

**NOTE 1:** If one team in Game #6 has had a bye, this team will play the winner of Game #5 in Game #7. If both teams in Game #6 have had a bye, these teams will play each other in Game #7 and the winner of Game #5 will receive a bye into Game #8 subject to Note 2.

**NOTE 2:** If, after Game #7, there are three teams with one loss each, the team having played the most games will receive the Game #9 bye. If two of the three remaining teams have played the same number of games, they will draw for the Game #9 bye. If all teams have played the same number of games, then all will draw for the Game #9 bye. **EXCEPTION:** If two of the teams played each other in both Game #6 and Game #7, only these two teams will draw for the Game #9 bye. [If three teams remain with one loss and all have played the same number of games, there will be two runners-up in the tournament.]

# OFFICIAL DYB SIX-TEAM DOUBLE ELIMINATION BRACKET

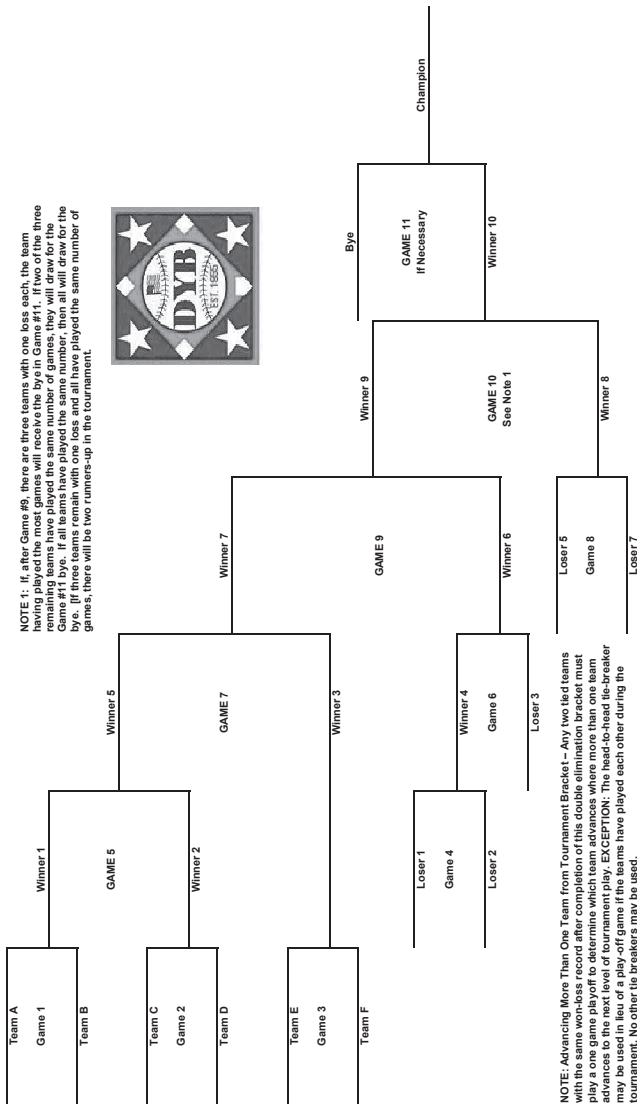

# OFFICIAL DYB SEVEN-TEAM DOUBLE ELIMINATION BRACKET

**NOTE 1:** If, after Game #11, there are three teams with one loss each, the team having played the most games will receive the Game #13 bye. If two of the three remaining teams have played the same number of games, they will draw for the Game #13 bye. If all teams have played the same number, then all will draw for the Game #13 bye. If three teams remain with one loss and all have played the same number of games, there will be two runners-up in the tournament.]

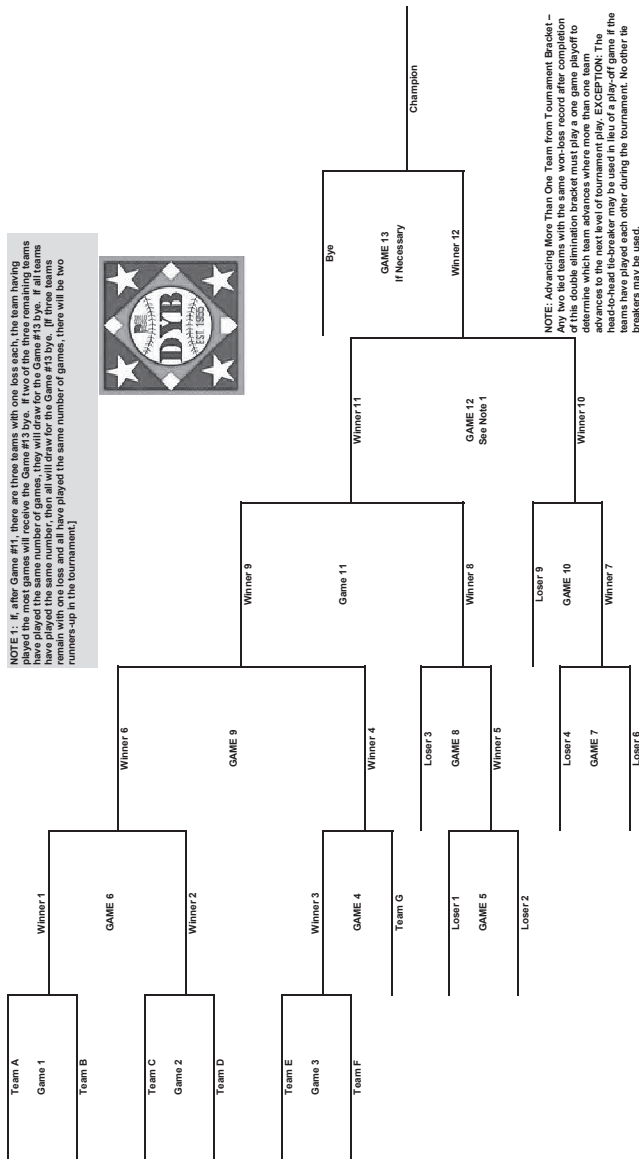

**NOTE:** Advancing More Than One Team from Tournament Bracket – Any two tied teams with the same win-loss record after completion of this double elimination bracket must play a one game playoff to determine which team advances where more than one team advances to the next level of tournament play. **EXCEPTION:** The head-to-head tie-breaker may be used in lieu of a play-off game if the teams have played each other during the tournament. No other tie breakers may be used.

# OFFICIAL DYB EIGHT-TEAM DOUBLE ELIMINATION BRACKET

NOTE 1: If, after Game #13, there are three teams with one loss each, they will draw for the Game #15 bye. If three teams have one loss each, there will be two runner-up in the tournament.

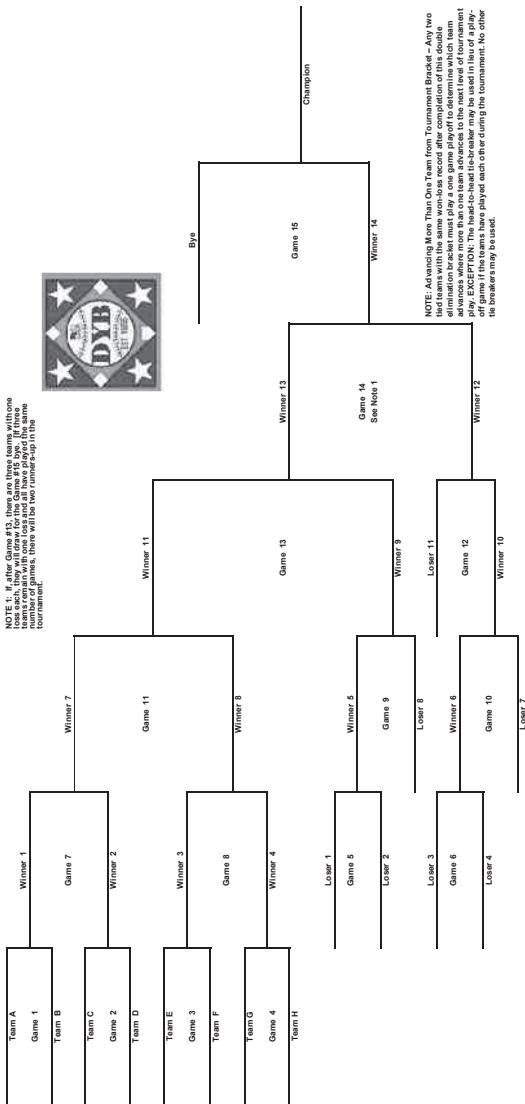

NOTE: Advancing More Than One Team from Tournament Bracket - Any two tied teams with the same won-lost record after completion of this double elimination bracket must play a one game playoff to determine which team advances where more than one team advances to the next level of tournament play. EXCEPT FOR: In head-to-head tiebreaker may be used in lieu of a playoff game. If the tiebreaker is played then either during the tournament, no other tie breakers may be used.

# OFFICIAL DIXIE YOUTH BASEBALL NINE-TEAM DOUBLE ELIMINATION BRACKET



NOTE 1: If, after Game #15, there are three teams with one loss each, the team having played the most games will receive the Game #17 Bye. (If two of the three remaining teams have played the same number of games, the team with the most games played will receive the Game #17 Bye. If three teams have played the same number of games, a random draw for the Game #17 Bye. If three teams remain with one loss and all have played the same number of games, there will be two runners up in the tournament.)

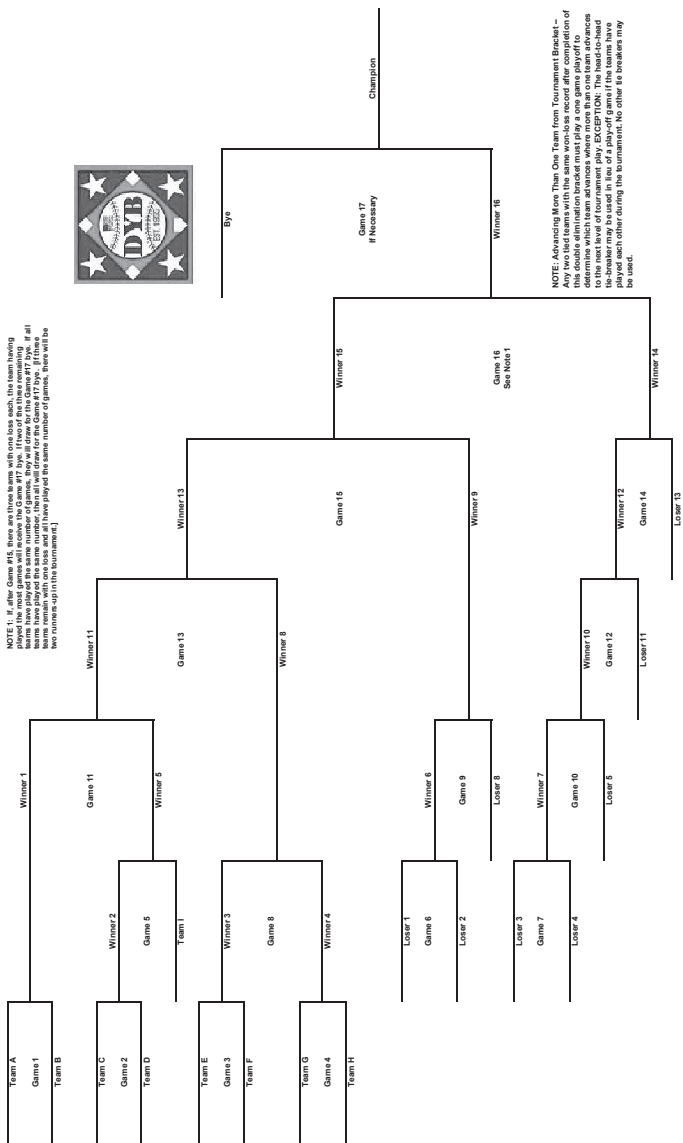

# OFFICIAL DIXIE YOUTH BASEBALL TEN-TEAM DOUBLE ELIMINATION BRACKET



**NOTE 1:** If, after Game #17, there are three teams with one loss each, the team that has played the most games will receive the bye in Game #18. If there are two teams with one loss each, the team that has played the most games will receive the bye. If all teams have played the same number of games, then all will draw for the bye. [If there are four teams with one loss each, and they have all played the same number of games, there will be two runners-up in the tournament.]

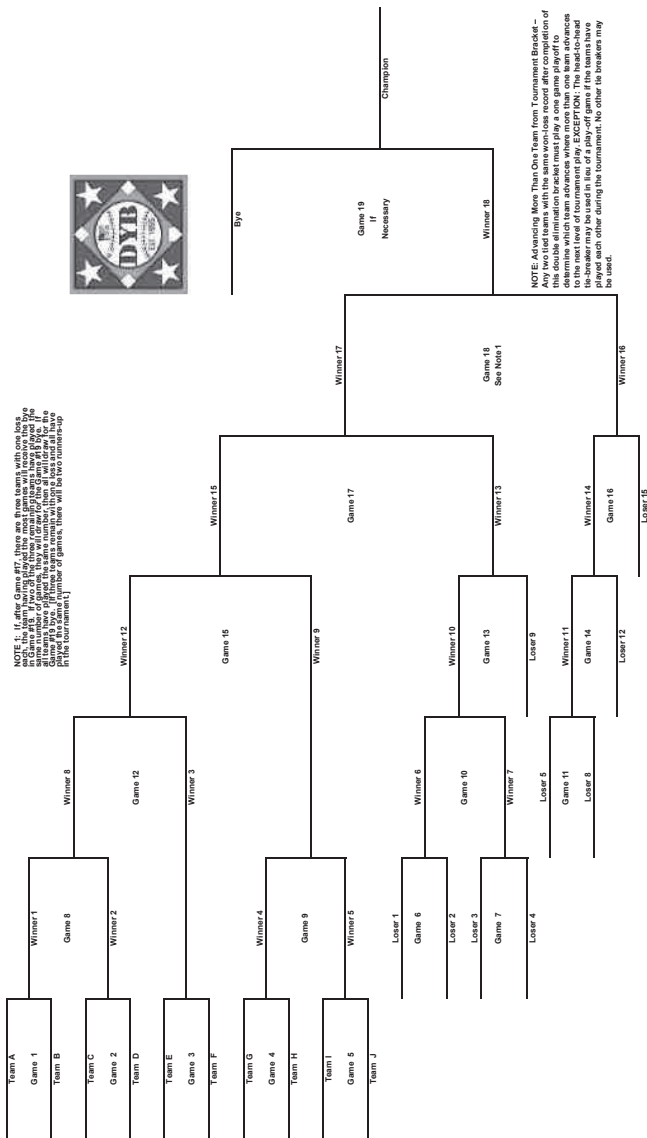

**NOTE:** Advancing More Than One Team from Tournament Bracket – Any two tied teams with the same won-lost record after completion of this double elimination bracket must play a one game playoff to determine which team advances where more than one team advances. The winner of the one game playoff will advance. The loser of the one game playoff may be used in lieu of a play-off game if the teams have played each other during the tournament. No other tie breakers may be used.

# OFFICIAL DIXIE YOUTH BASEBALL ELEVEN-TEAM DOUBLE ELIMINATION BRACKET

NOTE 1: If, after Game #19, there are three teams with one loss each, the team having played the most games will receive the bye in Game #21. If two teams of the three remaining teams have played the most number of games, the team having played the most games will receive the bye. If three teams remain with one loss each and all have played the same number of games, there will be two corners-up in the tournament.

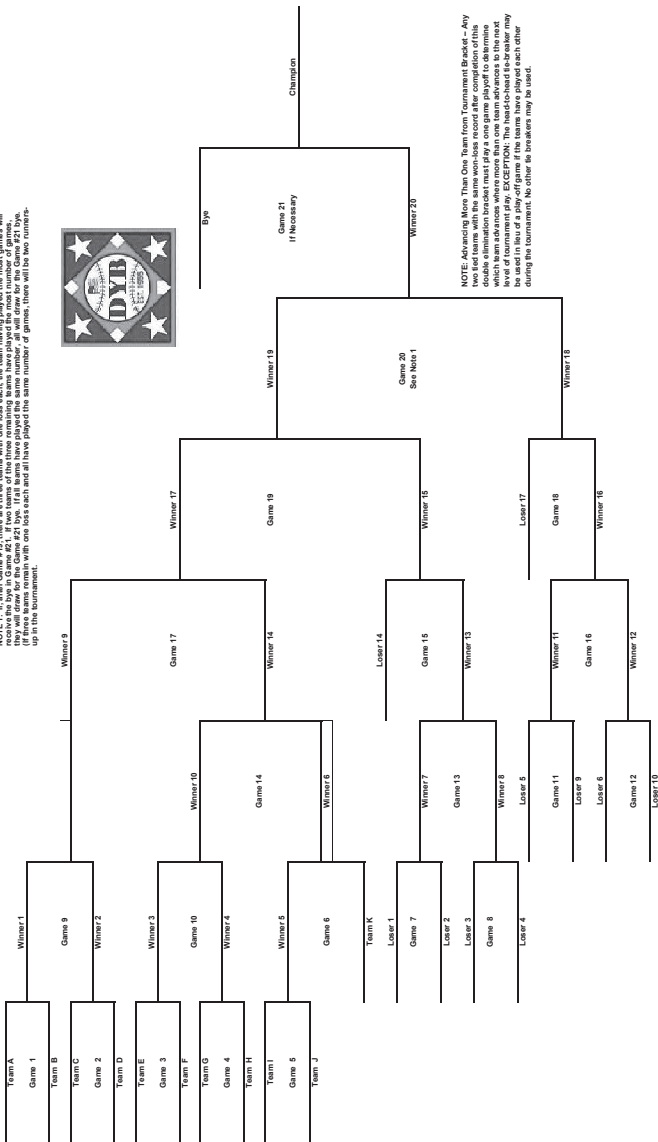

NOTE: Advancing More Than One Team from Tournament Bracket - Any team that advances from the double elimination bracket must play a one game playoff to determine which team advances where more than one team advances to the next level of tournament play. EXCEPTION: The head-to-head tie-breaker may be used in lieu of a play-off game if the teams have played each other during the tournament. No other tie breakers may be used.

# OFFICIAL DYB TWELVE-TEAM DOUBLE ELIMINATION BRACKET

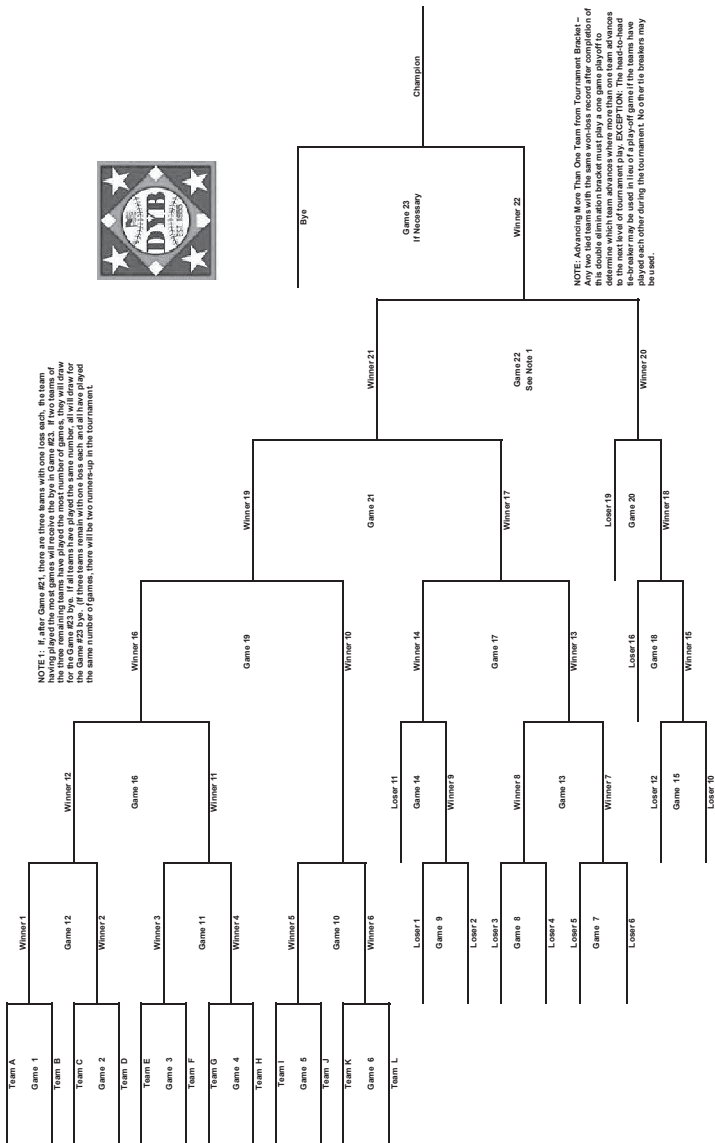

NOTE 1: If, after Game #21, there are three teams with one loss each, the team having played the most games will receive the bye in Game #23. If two teams of equal games played have the same number of games played, the team that advanced for the Game #23 bye. If all three teams have the same number of games played and the same number of games, there will be two runners-up in the tournament.

NOTE: Advancing More Than One Team from Tournament Bracket – Any two tied teams with the same won-loss record after completion of this double elimination bracket must play a one game playoff to determine which team advances where the other team advances to the next round. The one game playoff must be a standard 15-minute bracket game. A tiebreaker may be used in lieu of a play-off game if the teams have played each other during the tournament. No other tie breakers may be used.





# THE DYB STORE

[www.dybstore.org](http://www.dybstore.org)



Order online or download an order form for uniform patches, flags, hats, shirts, and more!

sportsengine

# Get out and play.

Find a team  
for your child to  
get involved with.

SportsEngine has the largest  
directory of sports teams and  
organizations in the U.S.

Find hundreds of clubs and  
leagues in your area to join today.

Learn more about your options at  
[www.sportsengine.com](http://www.sportsengine.com)



Official Partner of  
Dixie Youth Baseball



Sports Illustrated  
Play is now apart of  
SportsEngine



Official Ball of the Dixie Youth Baseball World Series



# CHANGE STARTS ON THE INSIDE

Meet the All-New 2021 A2000 Lineup,  
Now with Spin Control Technology.